



New Results of Development of Gyrotrons for Plasma Fusion Installations

Presented by G.G. Denisov

Institute of Applied Physics, Russian Academy of Sciences, 603950, Russia
Gycom Ltd, Nizhny Novgorod, 603155 Russia



26th IAEA Fusion Energy
Conference

17–22 October 2016 Kyoto,
Japan

Main results of

FIP/1-6Ra G. Denisov New Results of Development in Russia of Gyrotrons for Plasma Fusion Installations

Institute of Applied Physics, Russia
Gycom Ltd, Nizhny Novgorod, Russia

FIP/1-6Rb Development of Multifrequency Megawatt Gyrotrons for Fusion Devices in JAEA

R. Ikeda. National Institutes for Quantum and
Radiological Science and Technology (QST), Naka, Japan

FIP/1-6Rc Development of over-MW Gyrotrons for Fusion at Frequencies from 14 GHz to Sub-THz

T. Kariya. University of Tsukuba, Japan

List of the main activities on gyro-devices in IAP/GYCOM

- Gyrotron for plasma fusion (2015-2016)
 - **ITER activity**
 - EAST (first ECW experiment) +1
 - KSTAR (first delivery in 2015, acceptance test completed) +1
 - Asdex Upgrade
 - TCV
 - EU DA.....

- Gyrotrons for Technology/CVD diamonds/ECRIC/neutrons
- Gyro-TWT for radars
- THz gyrotrons
- Gyro-devices based on relativistic electron beams
- New ideas
 - Oscillation locking by external signal / stabilization by reflection
 - Generation of ultra short pulses

RF-DA gyrotrons: RF power sources for ITER ECRH plant

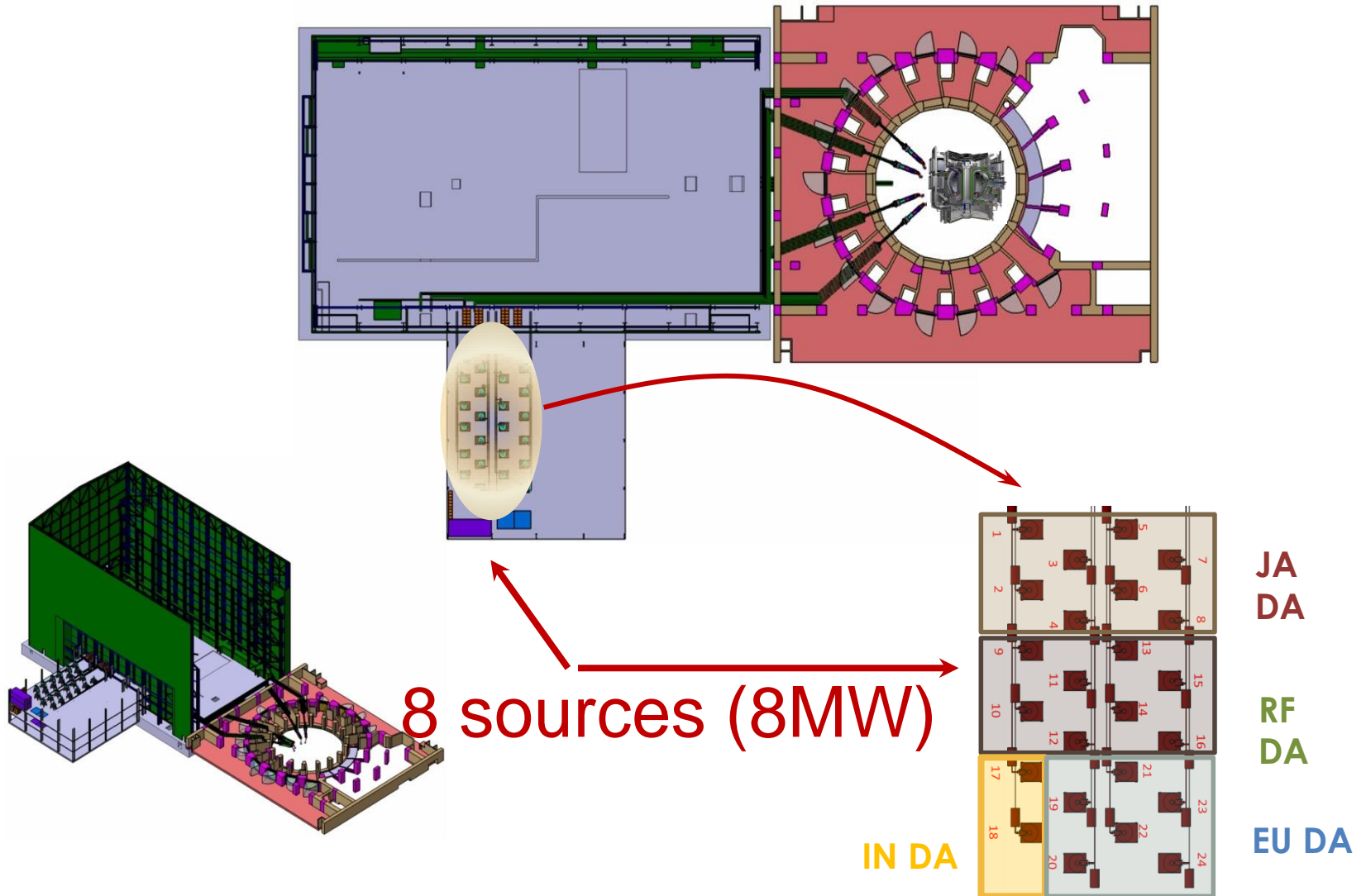

Gyrotron tube: main item of RF power source

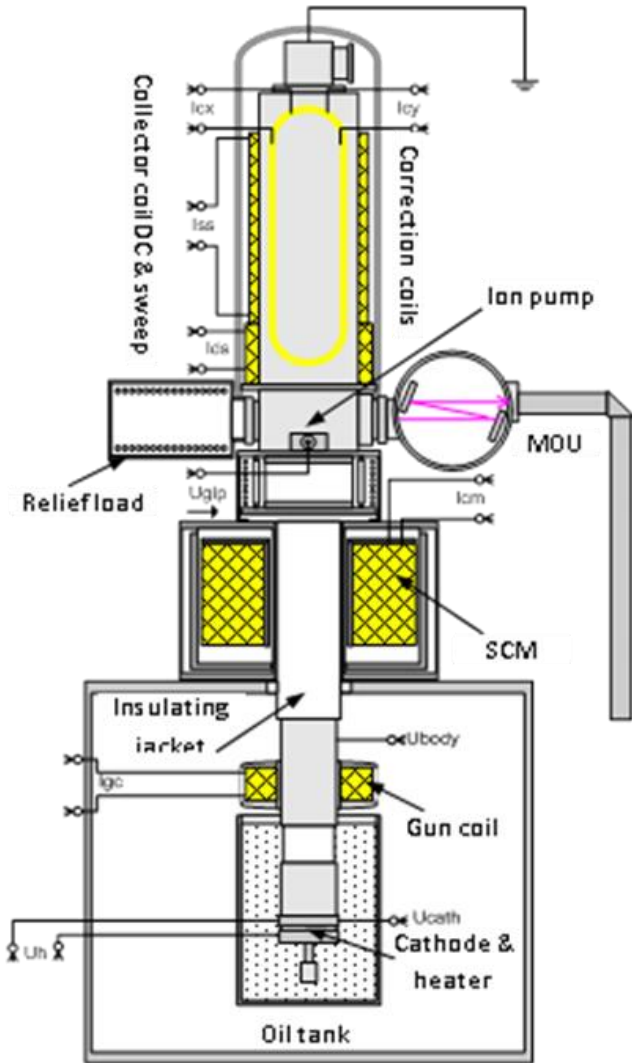

Gyrotron performance

Item	Specification
Nominal output power	0.96 MW at MOU output
Nominal frequency	170 ± 0.3 GHz including initial transient phase
Pulse length	1000/3600 sec
RF power generation efficiency	50 % (with CPD)
HE ₁₁ mode content	95 % at output waveguide (63.5 mm) of MOU
Modulation	100 % power depth modulation from 0 to 5 kHz
Height	~2.6 m
Weight	~250 kg



Dimpled wall converter

H_z field component

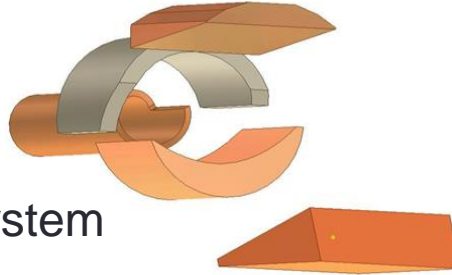
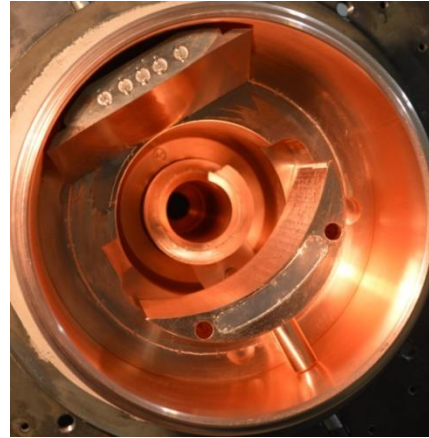
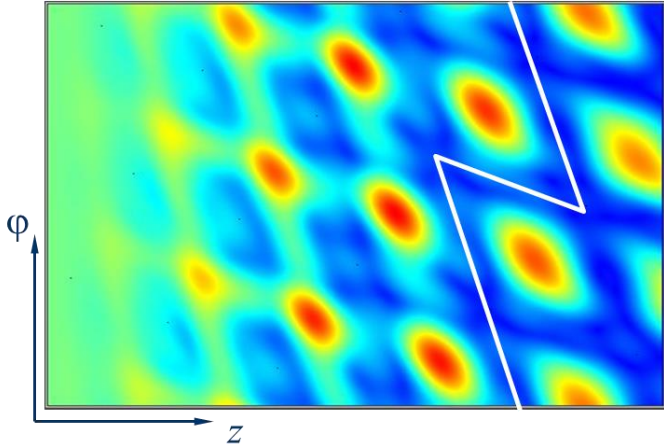

Four mirror QO system

TE_{25.10}

- 0.2° taper
- Azimuthal and axial ripples with ~0,1-mm perturbations

Synthesizing

- LOT/Surce-3D code
- 20 modes involved

Efficiency

- From the launcher to first parabolic mirror 99.5%
- From the cavity to output window 97.7%

Field amplitude and phase distribution at gyrotron window

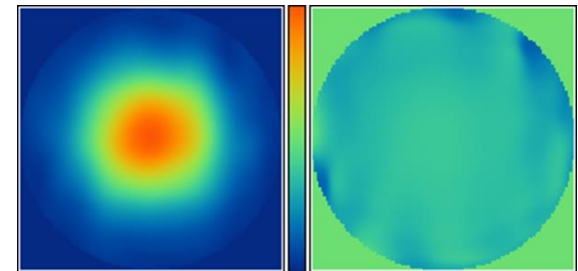

Diamond window

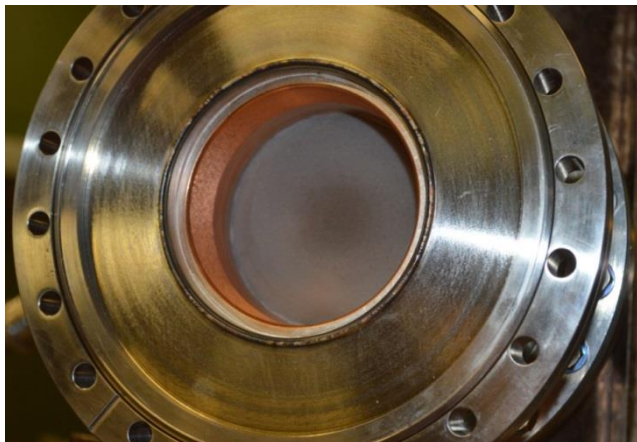

- Thickness of the diamond disk 1.853 mm, $5 \times \lambda/2$
- The disk diameter 106 mm, window aperture 82 mm
- As very high thermal conductivity, edge cooling possible

ITER RF Source prototype

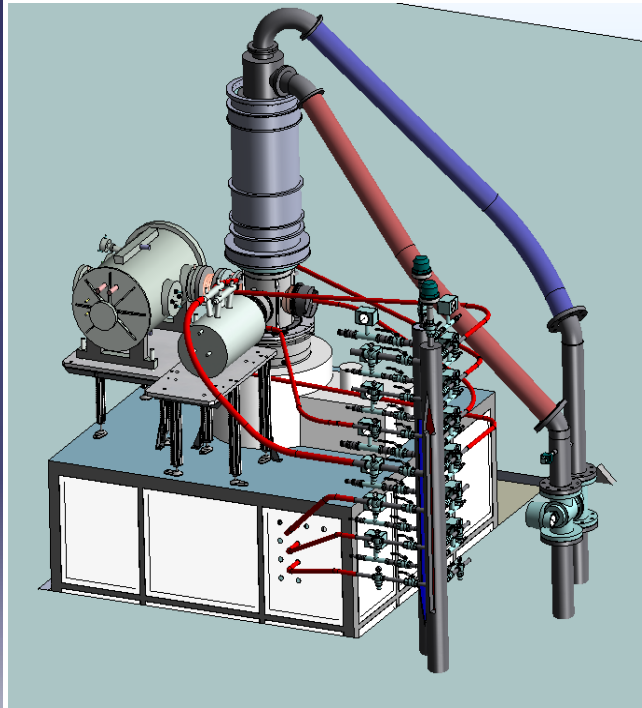
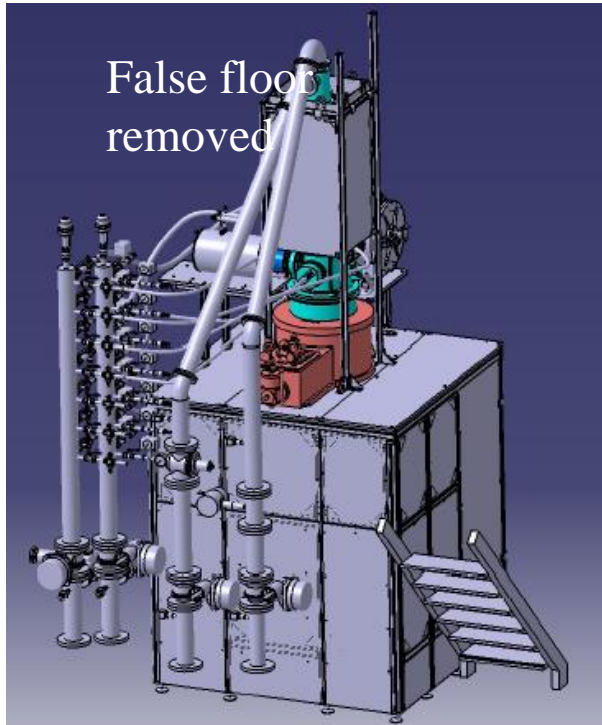

- Gun Coil Power Supply
- Collector DC coil Power Supply
- Temperature Monitor
- X and Y Correction coils Power Supplies
- Conductive Magnet Power Supply
- Filament Power Supply
- Collector
- Sweep coil Power Supply
- Ion Pump Power Supply

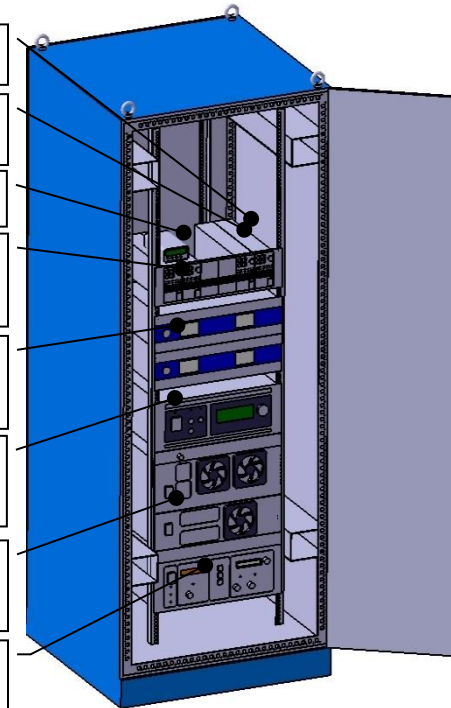

PROTOTYPE OF RF-DA RF POWER SOURCE, TEST REPORT

May 11 – 15, 2015, Nizhny Novgorod, Russia



Gyrotron together with
SCM, MOU and relief load
in the support structure
left picture



Waveguide with terminal
load and cooling manifolds
top right

Operator console with
control & protection cubicles
bottom right

Gyrotron for ITER: Recent Development Steps

Conceptual design

Run tests

Final design

Manufacture

Delivery

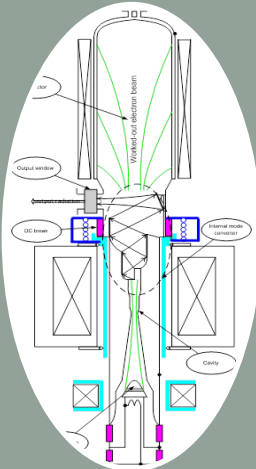

Long pulse operation of gyrotron pre-prototype in presents of IO representatives, April 2011



Run tests of gyrotron pre-prototype, 2014
 1MW output power
 500s – 160 pulses
 1000s – 55 pulses
 Reliability > 95%



Factory tests of Power Source Prototype successfully passed (IO representatives), May 2015
 FDR Procedure (Cadache, October 2015)

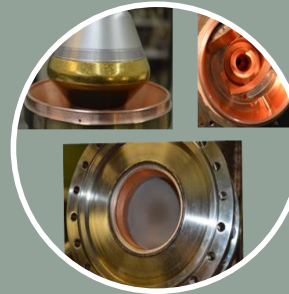

Manufacture and Inspection Plan.
 Quality Plan
 Manufacture readiness review
 Start of Manufacture 2016



Planned Delivering of the 1st Gyrotron System 2017
 RF Building Readiness 2018



Russian ITER RF Source pre-prototype

Gyrotron run test (2014) at 1MW output power
with pulse duration 500s and 1000s

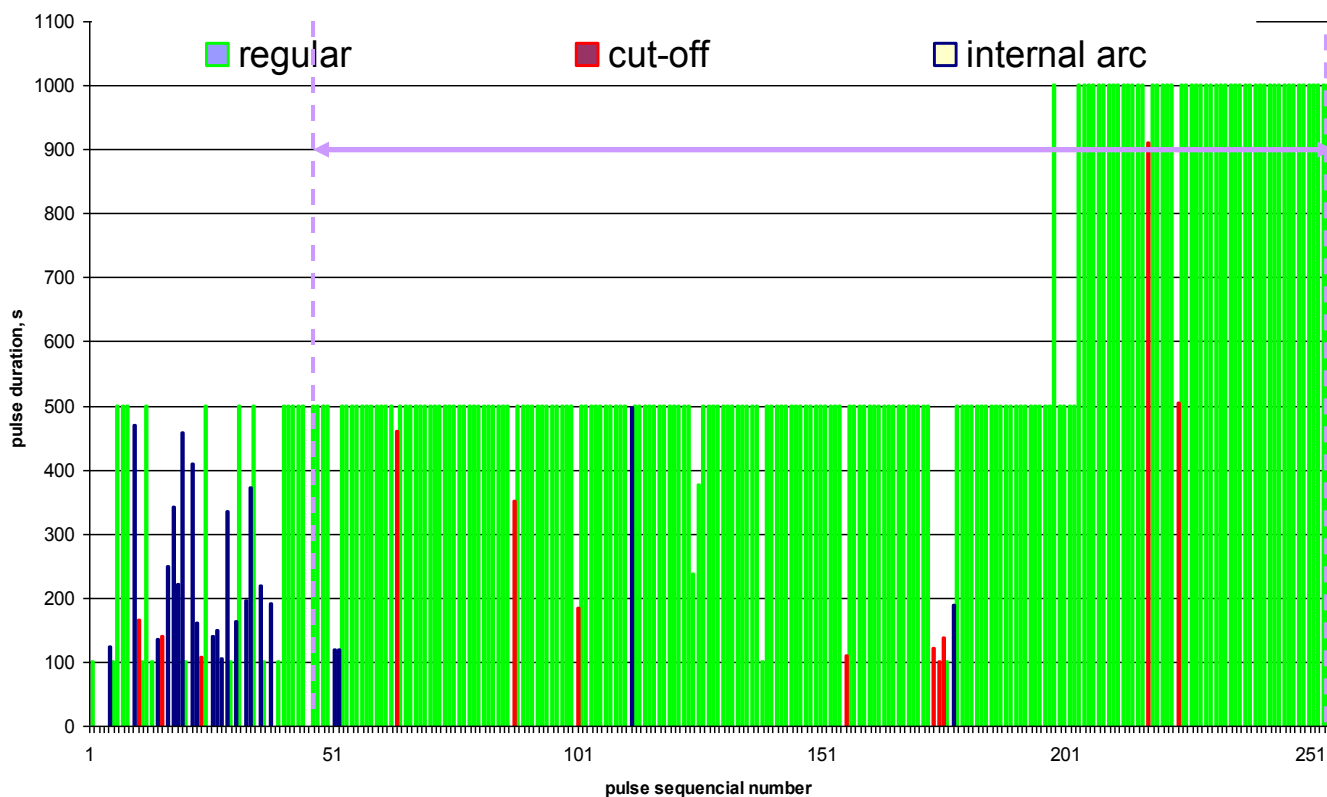

Reliability > 95%

500s – 160 pulses

1000s – 55 pulses



PROTOTYPE OF RF-DA RF POWER SOURCE TEST REPORT (Section 5) May 11 – 15, 2015, Nizhny Novgorod, Russia

PRFS testing was carried out on Factory site following RF source prototype FAT Program IDM_NCNC85 v.1.0 in presence of ITER organization (IO) representatives: **C. Darbos, F. Gandini and P. Vertongen.**

5. PRFS main output parameters measurement and verification for compliance for specified ones:	Required	Measured
- operation frequency,	170±0.25 GHz	170.07 GHz
- power at the MOU output,	≥0.96 MW	0.96 MW (±5%)
- generation efficiency	≥50%	58%
- HE ₁₁ mode content at MOU output	≥95%	97±1%
- pulse length	≥1000s	1000s
- duty factor	≤1/4	1/4

FDR, October 2015; Manufacturing began in 2016

Two-frequency 140 / 105 GHz gyrotron with 1 MW output power and maximum pulse duration 300 s. The parameters were successfully demonstrated at the customer site – NFRI / Korea. At present time gyrotron operates at plasma machine **KSTAR**. Second two-frequency gyrotron is planned for delivery to NFRI at the end of 2017.

140 GHz / 1 MW / 1000 s gyrotron operates at **EAST** machine / ASIPP / China since mid of 2015 year. Second tube passed factory tests at July, 2016 and delivered to China.

The deliveries besides the gyrotrons include other components: cryomagnets (JASTEC, Japan), matching optic units, elements of evacuated transmission lines and full power evacuated dummy load.

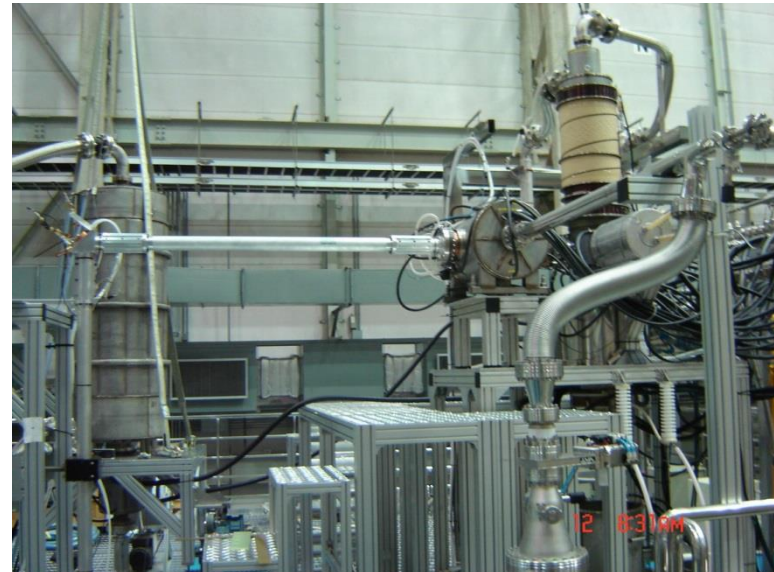

Gyrotrons at factory

and customer sites

New developments

- phase locking of gyro-oscillator by external signal
- stabilization of gyrotron frequency by the optimal reflection from a remote object
- generation of ultra-short pulses in gyro-TWT with non-linear absorber in the feedback loop

Aim:

- Provide single mode gyrotron operation at very high-order modes
- Stabilize frequency while e-beam parameters are not stable
- Enhance efficiency
- Lock frequency and phase / Make several gyrotrons coherent

Simulations show very promising perspectives in gyrotron frequency stabilization by an optimized (amount and position) reflection.

The new quasi-optical converter allows one to direct reflected signal precisely back into gyrotron cavity.

Experiment on frequency stabilization in the 170 GHz/2MW gyrotron (A.Kuftin, A.Chirkov, G.Denisov, 2016) is very encouraging.

For rather high voltage variation of 95-100 kV the frequency was stable within 2 MHz comparing with 30-40 MHz without reflection.

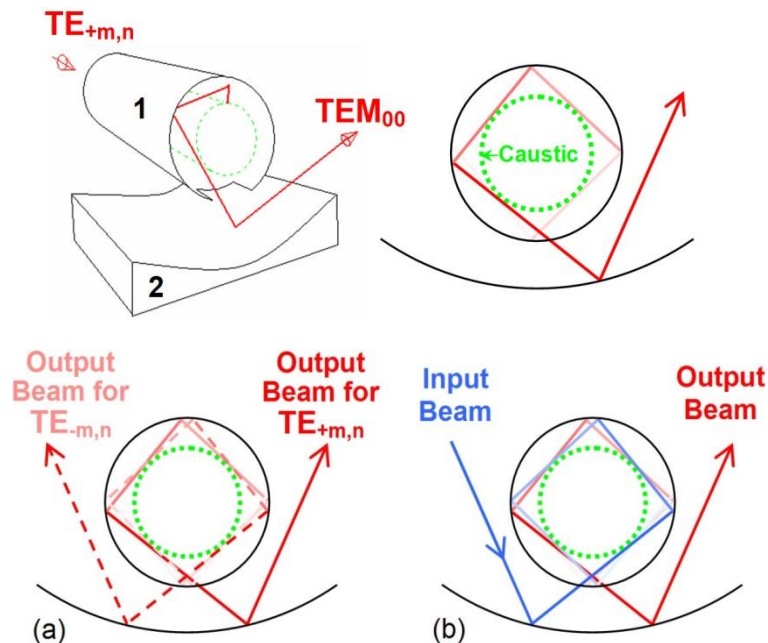

Conventional converter to transform gyrotron operation mode $TE_{m,n}$ into Gaussian beam:
 1 – launcher,
 2 – quasi-parabolic mirror.

Two operation regimes of novel mode converter:
 conversion of the both co- and counter modes – a)
 Input signal for freq./phase locking regime – b)

Development of Multi-Frequency Mega-Watt Gyrotrons for Fusion Devices in QST [FIP/1-6Rb]

R. Ikeda, T. Kobayashi, Y. Oda, K. Kajiwara,
K. Takahashi, S. Moriyama and K. Sakamoto

National Institutes for Quantum and
Radiological Science and Technology (QST)
Naka, Japan

Two types of multi-frequency gyrotrons equipped with a triode magnetron injection gun for **ITER** and **JT-60SA** have been developed.



Progress on development of JADA ITER gyrotron

JADA procures 8 sets.

1.2MW/~ 50 %

300sec steady-state operation

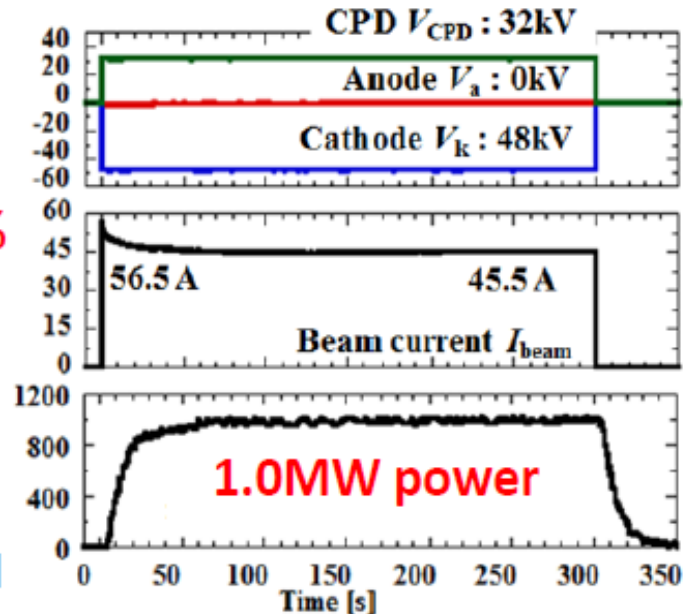
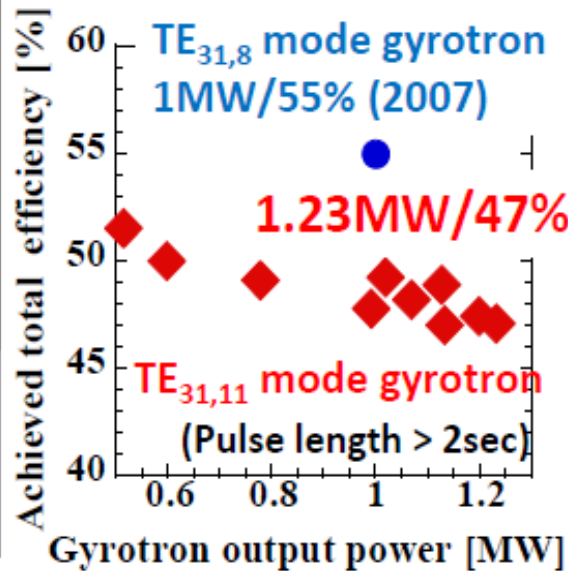
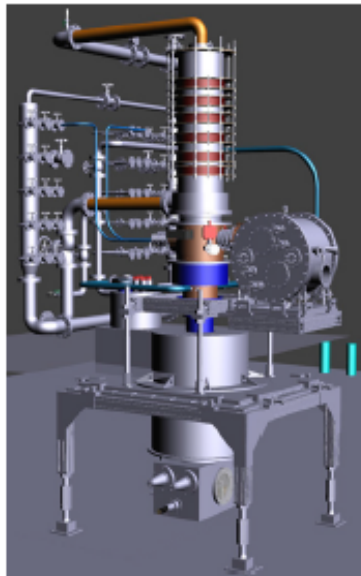

- Over-1MW gyrotron by TE_{31,11} mode has been developed
- 1.2MW power and ~ 50% efficiency have been demonstrated.
- 1.0MW long-pulse operation has been reached steady-state.
- 1.3MW long-pulse operations will be planned for ITER.
- Final design review of RF source was finished at 2015 and manufacturing of ITER gyrotrons (#1) are started.

Demonstration of Quad-frequency oscillations

JA ITER gyrotron has ability of multi-frequency oscillations with uniform directional beam.

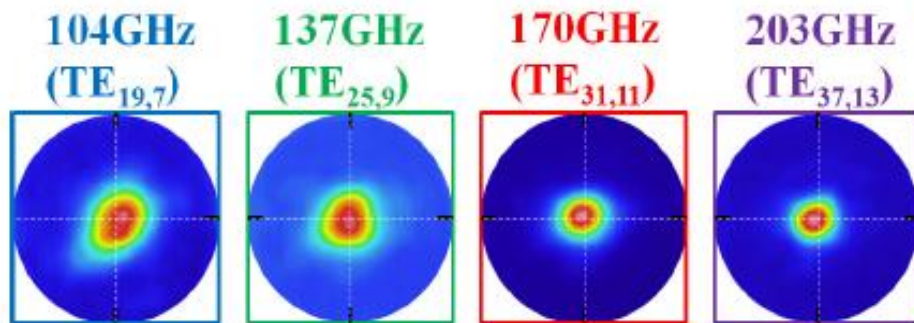

For Next generation

- Achievement of 203GHz oscillations using high order mode ($TE_{37,13}$ mode)
- 0.4MW for 5s (World first)
(Max : 0.9 MW / 0.3ms)

Expansion of pulse length for lower frequencies

- 137GHz ($TE_{25,9}$ mode)
1.0MW up to 6s
- 104GHz ($TE_{19,7}$ mode)
0.9MW up to 5s

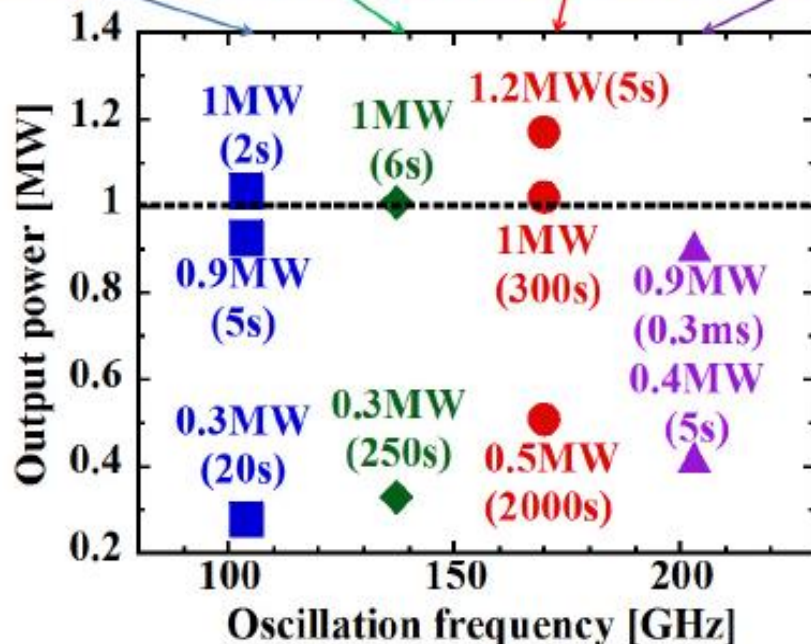

Multi-scenario by Triple-frequency gyrotron



JT-60SA EC system
(> 7 MW EC power)

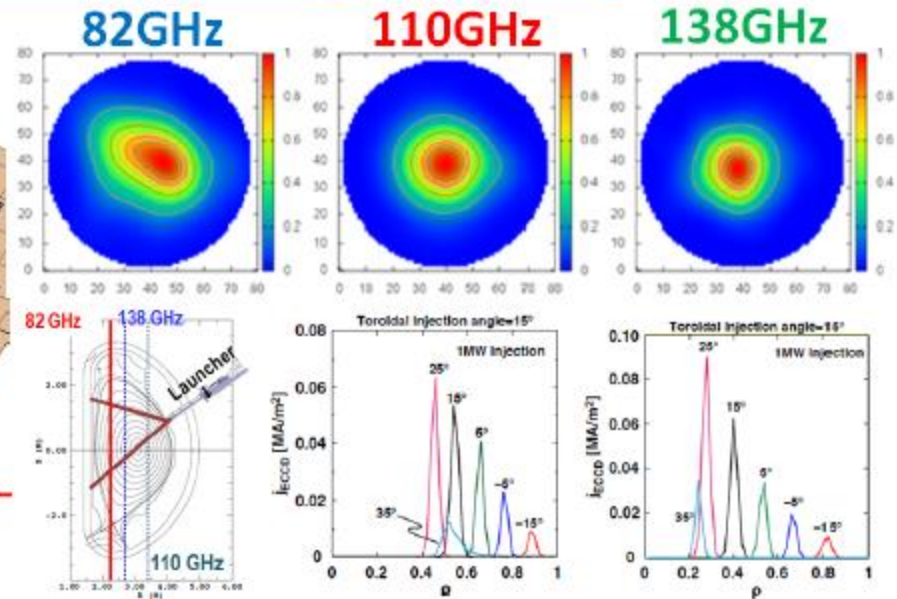
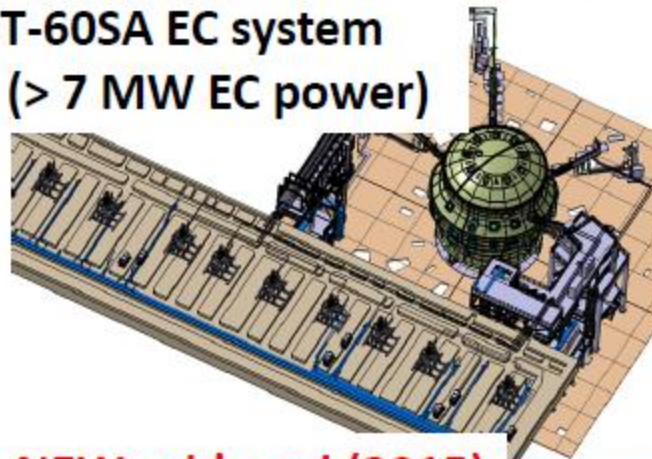

NEW achieved (2015)

➤ 82GHz(O1) [1MW/1s]

$B_T \sim 2.25$ T : Plasma start-up assist
EC wall cleaning

Achieved (2014)

➤ 110GHz(X2) [1MW/100s]

$B_T \sim 1.7$ T: High-beta operation

➤ 138GHz(X2) [1MW/100s]

$B_T \sim 2.3$ T: Large current operation ($I_p=5.5$ MA)

JT-60SA gyrotron will support attractive operations for fusion plasma research !

Demonstration of 2MW-class output power

➤ World record of 1.9MW has been achieved !

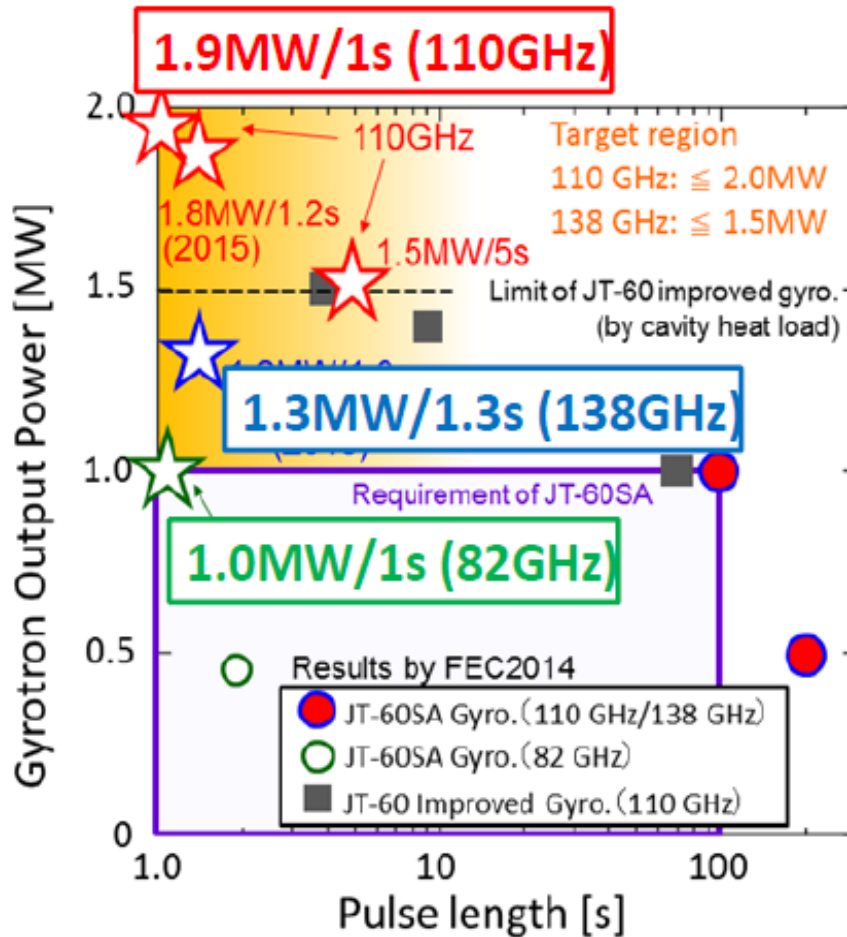

Maximum output power :

JT-60U gyrotron : 1.5MW/4s
(TE_{22,6} mode)



JT-60SA gyrotron : **1.9MW/1s**
(TE_{22,8} mode) 1.5MW/5s

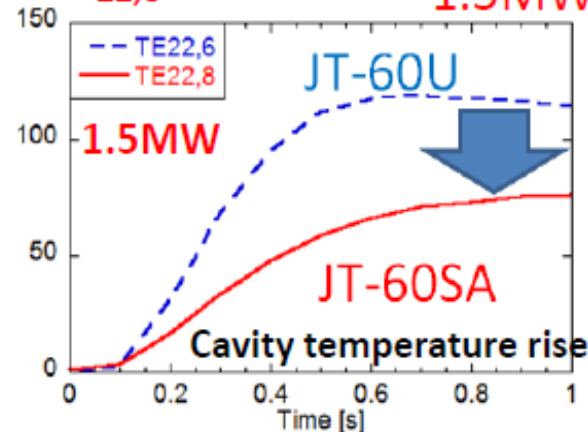

The output power is close to maximum acceptable power for the cavity in design.

➤ Maximum power at 138GHz has been enhanced to 1.3MW(1.3 s).

Development of Over MW Gyrotrons for Fusion at Frequencies from 14 GHz to Sub-terahertz

FIP1-6Rc

Presented by T. Kariya (Univ. Tsukuba)

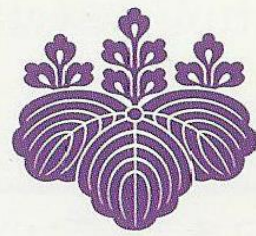

T. Kariya, T. Imai, R. Minami, T. Numakura, K. Tsumura, Y. Ebashi, Y. Endo, R. Ikezoe, Y. Nakashima : *Plasma Research Center (PRC), University of Tsukuba*

K. Sakamoto, Y. Oda, R. Ikeda, K. Takahashi, T. Kobayashi, S. Moriyama : *National Institutes for Quantum and Radiological Science and Technology (QST)*

T. Shimosuma, S. Kubo, Y. Yoshimura, H. Takahashi, H. Igami, S. Ito, K. Okada, S. Kobayashi, T. Mutoh : *National Institute for Fusion Science (NIFS)*

H. Idei, K. Hanada : *Research Institute for Applied Mechanics, Kyushu University*

K. Nagasaki : *Institute of Advanced Energy, Kyoto University*

M. Ono : *Princeton University Plasma Physics Laboratory (PPPL)*

T. Eguchi, Y. Mitunaka : *Toshiba Electron Tubes and Devices Co., Ltd (TETD)*

Univ. of Tsukuba has been developing over 1 MW gyrotrons of **14GHz to sub-THz** for Fusion Devices and for Demo-Reactor in collaboration with

QST, NIFS, Kyushu Univ., Kyoto Univ., PPPL and TETD, based on 2 MW level result on the LHD 77 GHz gyrotron tube.

Develop. of Sub-Terahertz (300 GHz) Gyrotron



For ECH and ECCD at the DEMO reactor (Collabo. with QST)

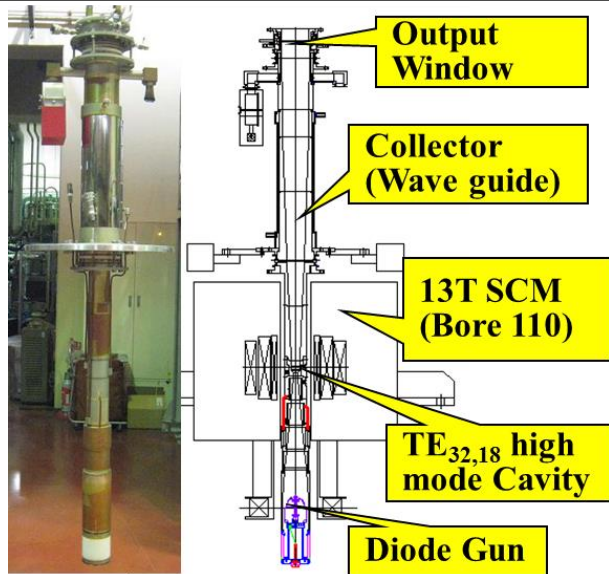

Conventional type gyrotron (W/O mode converter)

Achieved 299.8 GHz, 522 kW, 2 ms with TE_{32,18} single-mode

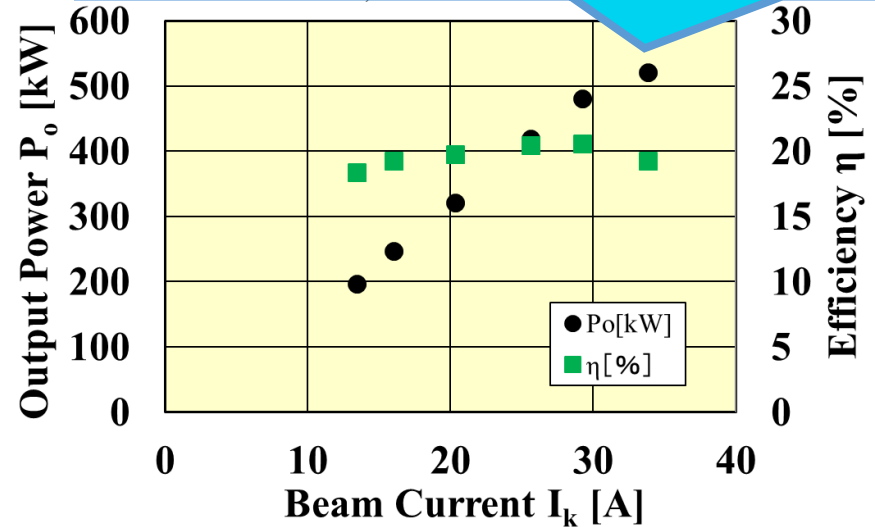

Mode maps (cavity vs. gun coil current)

Output Window Reflectance :
0% for TE_{32,18}, 23% for TE_{30,19}

With SiO₂ disk
20% for TE_{32,18}, 2% for TE_{30,19}

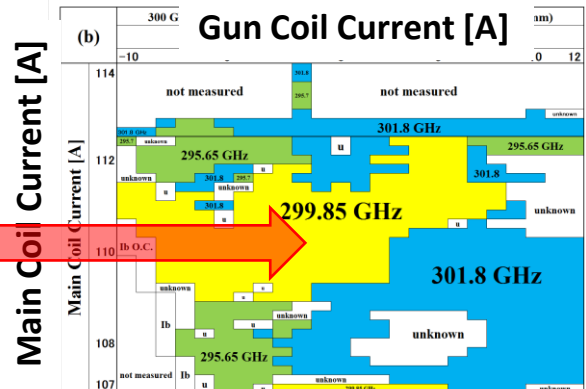
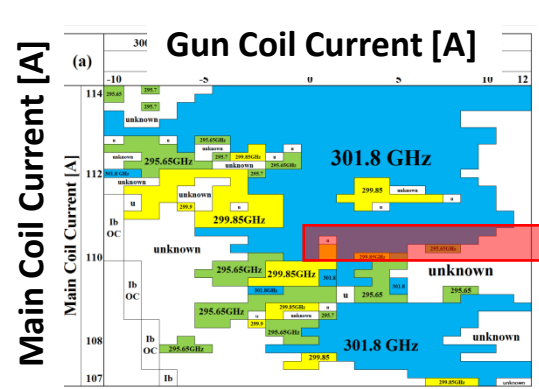

Window reflection affects the oscillation mode characteristics, which can be removed by installing a built-in mode converter. The aimed design single mode would be realized.

295.65 GHz, 542 kW (TE_{31,18})
301.8 GHz, 528 kW (TE_{30,19})

Develop. of Sub-Terahertz (300 GHz) Gyrotron

For ECH and ECCD at the DEMO reactor (Collabo. with QST)



Stable single mode oscillation at each tuned freq. in 225–254 GHz band

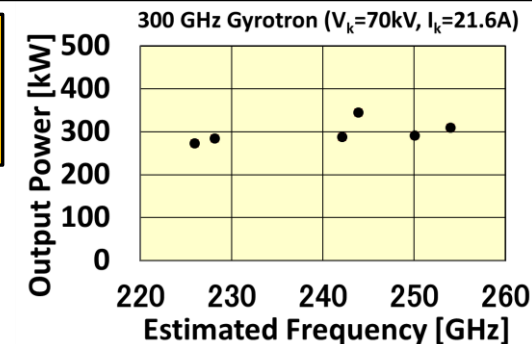

220 - 240 GHz Oscillation by 300 GHz Gyrotron

Magnetic Field at Cavity [T]	Beam Radius [mm]	Estimated Oscillation Mode	Estimated Frequency [GHz]
10.11	5.57	$\text{TE}_{28,15}^{(-)}$	253.99
9.80	5.58	$\text{TE}_{27,15}^{(-)}$	250.04
9.60	5.59	$\text{TE}_{28,14}^{(-)}$	243.9
9.54	5.59	$\text{TE}_{25,15}^{(+)}$	242.1
9.43	5.6	?	?
9.07	5.61	$\text{TE}_{24,14}^{(+)}$	228.13
8.90	5.62	$\text{TE}_{26,13}^{(-)}$	225.96

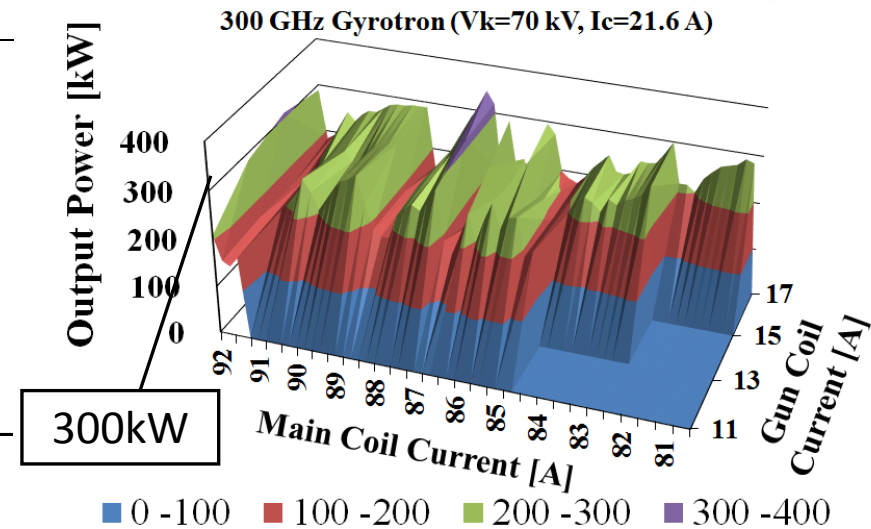

It was found that designed ultra-high volume mode of sub-THz would be stably obtained with conventional cylindrical cavity. Step tunable single mode oscillations were also confirmed. These result contributes greatly to the **step frequency tunable gyrotron** in the **sub-THz** region for the **DEMO-Reactor**.

Develop. of 28/35 GHz Dual-frequency Gyrotron



For ECH, ECCD & EBW heating on GAMMA 10/PDX, QUEST, Heliotron J, NSTX-U
(Collabo. with Kyushu Univ., Kyoto Univ., PPPL and NIFS)

QUEST experiment using Tsukuba 28 GHz gyrotron :

Over-dense plasma with a density in excess of $1 \times 10^{18} \text{ m}^{-3}$ (higher than the cut-off density of 8.2 GHz) was produced. An EC-driven plasma current of 70 kA was achieved non-inductively for a 28 GHz injection [EX/P4-50 : H. Idei].

Next step Collaboration

New Dual-frequency Gyrotron

28 GHz 2 MW Dual-frequency Gyrotron			
Frequency	28 GHz	34.77 GHz	
Output Power	2 MW 0.4 MW	1 MW	
Pulse Width	3 s CW	3 s	
Output Efficiency	50% (with CPD)		
Beam Voltage	80 kV 70 kV	80 kV	
Beam Current	70 A 20 A	40 A	
MIG	Triode		
Cavity mode	TE _{8,5}	TE _{10,6}	
Mode Converter	Built-in		
Output mode	Gaussian like		
Output Window	Sapphire Double Disk		
Collector	Depressed Collector		
	Sweeping coils		

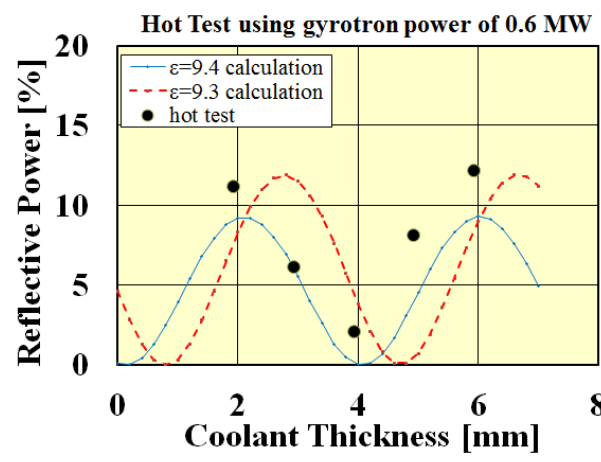
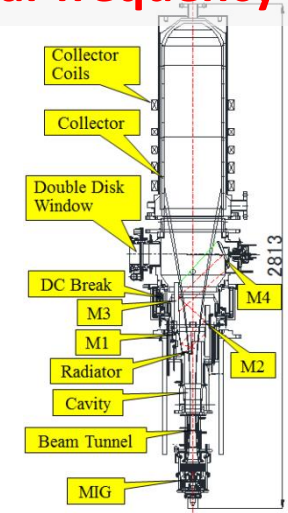

Double-disk window

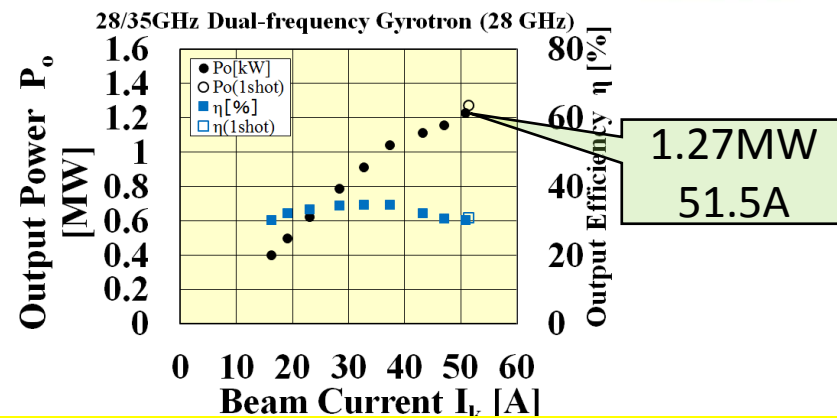
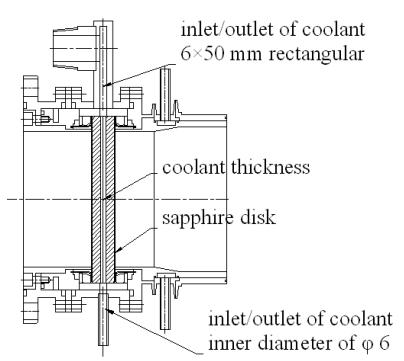

The frequency characteristics of the **double-disk window** were optimized. The results suggest the **flexibility of the window transparent frequency**.

Oscillations of **28.04 GHz, 1.27 MW** and **34.83 GHz, 0.48 MW** were obtained with Gaussian-like beams. Maximum Efficiency **50%** was obtained at **0.63MW** with $V_{cpd} = 30 \text{ kV}$

Design study of 154/116 GHz Dual-frequency gyrotron

For ECH and EBW heating at LHD (Collab. With NIFS)



Three 77 GHz and two 154 GHz gyrotrons have contributed greatly to extending the LHD plasma performance with their total plasma injection power of 5.4 MW.

- High Te plasma : $T_e = 20 \text{ keV}$
- Steady-state plasma : line averaged $n_e = 1.1 \times 10^{19} \text{ m}^{-3}$ $T_e = 2.5 \text{ keV}$ was sustained for 2351 s.

Based on the above and the 2 MW level 77 GHz gyrotron development results, a new 154/116 GHz dual-frequency gyrotron is desired for expanding the LHD plasma parameters.

Best matching of cavity, Mode convertor and window was obtained with combination of Cavity oscillation modes $TE_{28,9}$ at 154 GHz and $TE_{21,7}$ at 116 GHz.

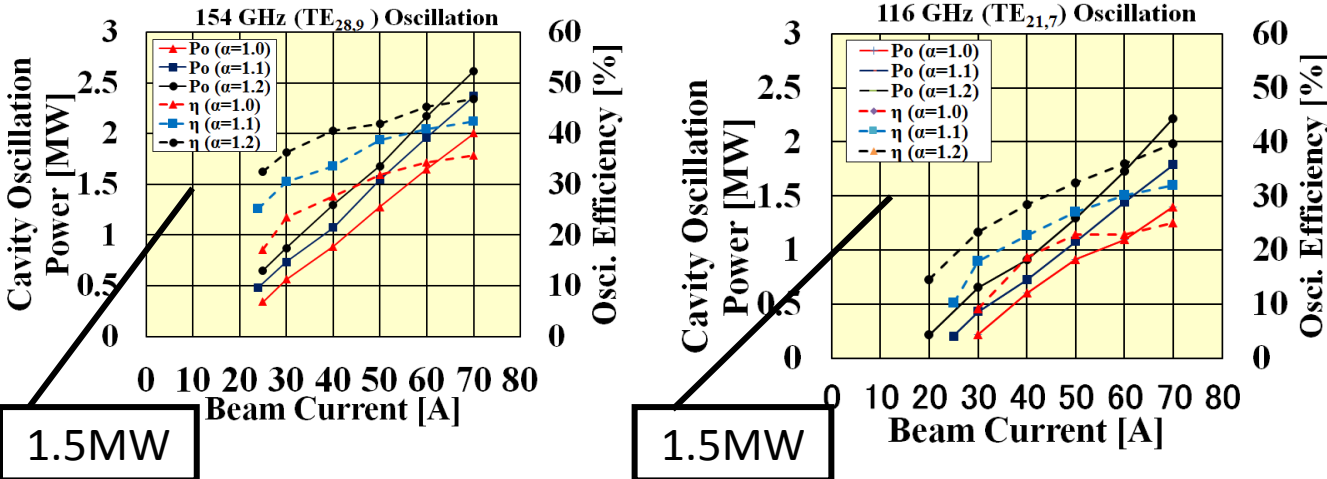

The simulation of the MIG indicates the operation at $\alpha = 1-1.2$ with $\Delta\alpha/\alpha < 5\%$, implying high efficient oscillations in the cavity.

Oscillations with the power exceeding **1.5 MW** are expected at 154 and 116 GHz.

Summary

- Significant progress in gyrotron development was demonstrated (Russia and Japan) in two last years
- Aims and achievements of the new developments are:
 - Reliability of gyrotron operation (ITER)
 - Higher power and higher frequency
 - Multi-frequency operation (e.g. 104, 137, 170, 203 GHz)

Thank you!

ありがとうございます