



Overview of the physics and diagnostics modelling activities for the EU-DEMO divertor

M. Siccinio, W. Biel, M. Cavedon, S. El Shawish, E. Fable, G. Federici, L. Giannone, Th. Härtl, V. Hauer, F. Janky, A. Kappatou, F. Maviglia, F. Subba, S. Varoutis, Ch. Vorpahl, H. Wu

3rd IAEA TM on Divertor Concepts
IAEA Headquarters, Vienna, Austria, Nov. 4th-7th 2019



This work has been carried out within the framework of the EUROfusion Consortium and has received funding from the Euratom research and training programme 2014-2018 and 2019-2020 under grant agreement No 633053. The views and opinions expressed herein do not necessarily reflect those of the European Commission.



- **Introduction**
- **ASTRA/Simulink integrated modelling**
 - ❖ Model and assumptions
 - ❖ DEMO-related results
- **SOLPS modelling**
 - ❖ Fluid cases
 - ❖ Kinetic cases
 - ❖ Pumping
 - ❖ Synthetic diagnostics
- **Divertor reattachment**
 - ❖ Divertor reattachment in EU-DEMO
 - ❖ Impact on the machine design
- **Conclusions**





- **Introduction**
- **ASTRA/Simulink integrated modelling**
 - ❖ Model and assumptions
 - ❖ DEMO-related results
- **SOLPS modelling**
 - ❖ Fluid cases
 - ❖ Kinetic cases
 - ❖ Pumping
 - ❖ Synthetic diagnostics
- **Divertor reattachment**
 - ❖ Divertor reattachment in EU-DEMO
 - ❖ Impact on the machine design
- **Conclusions**





The divertor physics modelling for EU-DEMO follows **two different lines of study**:

- 1. Integrated modelling for dynamic simulations:** an integrated ASTRA/Simulink model is able to reproduce (in a simplified way) DEMO dynamic phases, and helps to identify criticalities that a steady-state analysis cannot catch.
- 2. SOLPS simulations** for detailed understanding and input to engineering activities (e.g. dimensioning of the pump, development of synthetic diagnostics et cetera).

In this presentation, both lines of study are reviewed, focusing in particular on the first one.



- Introduction
- **ASTRA/Simulink integrated modelling**
 - ❖ Model and assumptions
 - ❖ DEMO-related results
- SOLPS modelling
 - ❖ Fluid cases
 - ❖ Kinetic cases
 - ❖ Pumping
 - ❖ Synthetic diagnostics
- Divertor reattachment
 - ❖ Divertor reattachment in EU-DEMO
 - ❖ Impact on the machine design
- Conclusions





The model

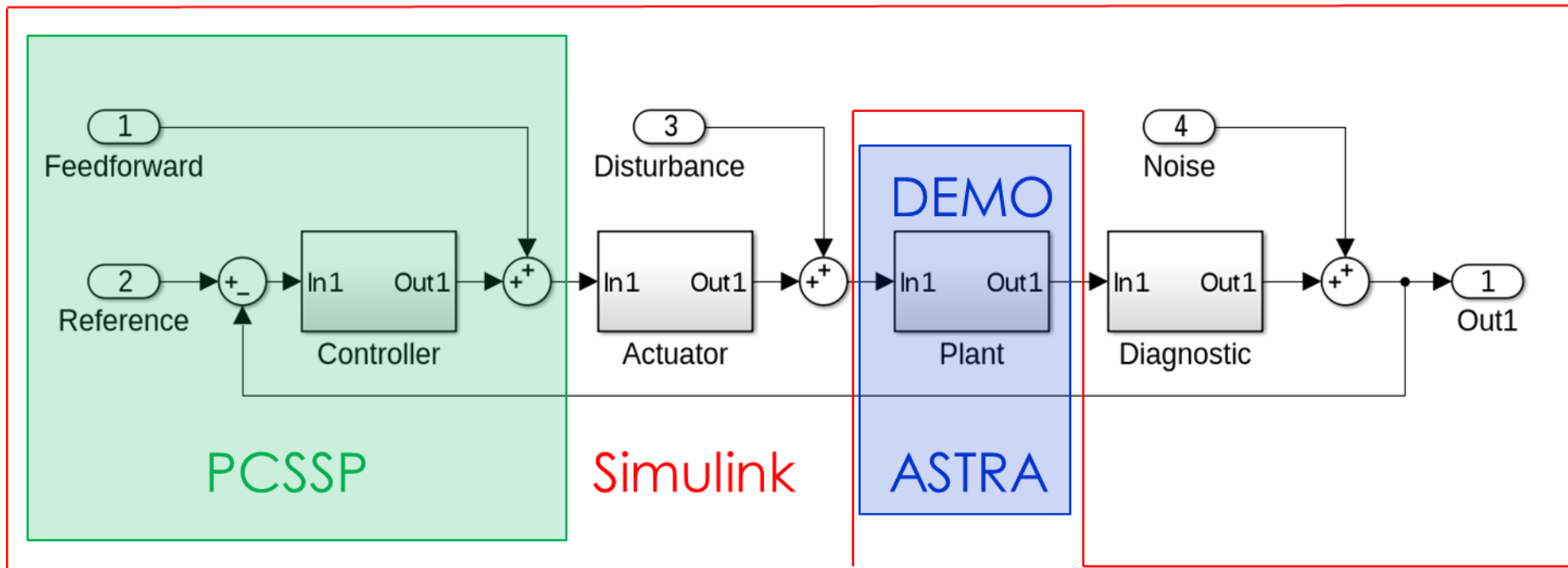

Plasma Control System Simulation Platform - (PCSSP)

- Framework developed within Simulink for ITER tokamak with control system based on AUG control system architecture
- Waveforms for the references and for pre-programmed trajectories
- Events generators
- Easily adaptable to different machines (currently ITER, DEMO, AUG as FENIX)
- **No magnetic control yet (but we are working on that)**



Physics - core

- ❑ 1-D transport code
- ❑ SPIDER for 2D MHD equilibrium (in this study fixed boundary)
- ❑ Core transport model: semi-empirical model fitted to the present experiment (ASDEX Upgrade - AUG) [Erba, NF 1998]

$$\chi \propto q^2 \frac{T_e^{1.5}}{B_t^2 a^2} \frac{a}{L_p} + \chi_{neo}; \quad L_p = \left| \frac{\partial p}{p \partial r} \right|^{-1}$$

- ❑ L-H/H-L model with no hysteresis based on $P_{sep} > P_{LH}$ [Martin Y.R., J. Phys.: Conf. Ser. 2008]

$$P_{LH} = 1.53 B_t^{0.78} R^{1.75} (a/R)^{0.57} (n20)^{0.66}$$

- ❑ Sawtooth model - complete reconnection (flattening) if magnetic shear $s > s_{crit}$

$$s_{crit} = 0.1 + \frac{0.3}{400} P_\alpha; \quad s = \frac{r}{q} \frac{dq}{dr}$$

- ❑ Pedestal model – ion neoclassical transport for $T_{i,e}$, $n_{i,e}$; pedestal top pressure saturates according to EPED scaling $\sim \beta_N^{0.43}$ [Fable, FED, 2018]



Physics – edge

- SOL/div 0-D particle balance model for main fuel and impurity seeding

$$\frac{dN_j^{sol}}{dt} = \Gamma_j^{plasma} - \Gamma_j^{wall} + \Gamma_j^{mid-plane\ puff} - D_j(N_j^{sol} \cdot \epsilon_j - N_j^{div})$$

$$\frac{dN_j^{div}}{dt} = \Gamma_j^{divpuff} - \Gamma_j^{pump} + D_j(N_j^{sol} \cdot \epsilon_j - N_j^{div})$$

Enrichment factor ϵ_j – Ar 20, Xe 6, He 1.2, W 6;

– D_j – SOL/div time scale = 1 [s⁻¹]

A better estimate of the enrichment factor is an essential piece of information for a correct assessment of the machine performance!

[M. Wischmeier, IAEA TM 2017]



Physics – edge (cont.)

□ **SOL/div analytical exhaust model** fit to 0D integral model [Siccinio, PPCF 2016]

– in practice

$$T_{div} \propto \frac{P_{sep} B_t}{q A R} \cdot \arctan(c \cdot y^{16}); \quad y = \frac{P_{sep} B_t}{q A R N_e^{sep} N_{Ar}^{div}}$$

– W flux model:

$$\Gamma_W \propto \sqrt{\max(0, T_{div} - 5)} \sum_j n_j^{div} m_j (1 - f_r); \quad f_r = 0.95$$

f_r – redeposition factor; j - species

Very steep curve around detachment! (at constant N^{sep})

Jumps possible (are they physical?)

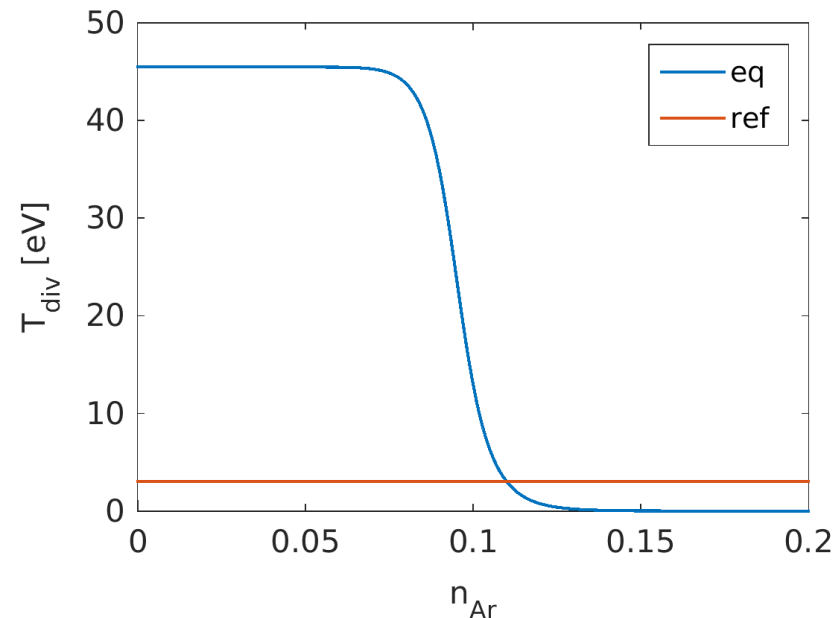



- Currently use **ideal diagnostics** but quantities are those that will be measured according to the assumed diagnostics for DEMO
- *Realistic* pellet actuators according to AUG technology
 - Different pellet size, success rate and launch frequencies
- Delays on every actuator based on realistic assumptions
- Transport coefficient χ with random noise 5% (*mimicking plasma fluctuations*)
- Controllers with programmed waveforms and feedback components

Example:

- Fusion power P_{fus}
 - **Target:** 2 GW
 - **Actuators:** NBI, pellet D/T ratio, pellet frequency
 - **Diagnostics:** ideal (in reality: neutrons and gammas)
- Divertor temperature
 - **Target:** < 3 eV
 - **Actuators:** Ar or Kr gas puff to divertor
 - **Diagnostics:** *divertor temperature*



Reach operational point

- Ideal pellet actuator
- n_e reference step
- Big influence on fusion power
- 100 MW NBI power is not sufficient enough to compensate the drop (NBI saturated)
- Operational points must satisfy both physics limits and actuator margins

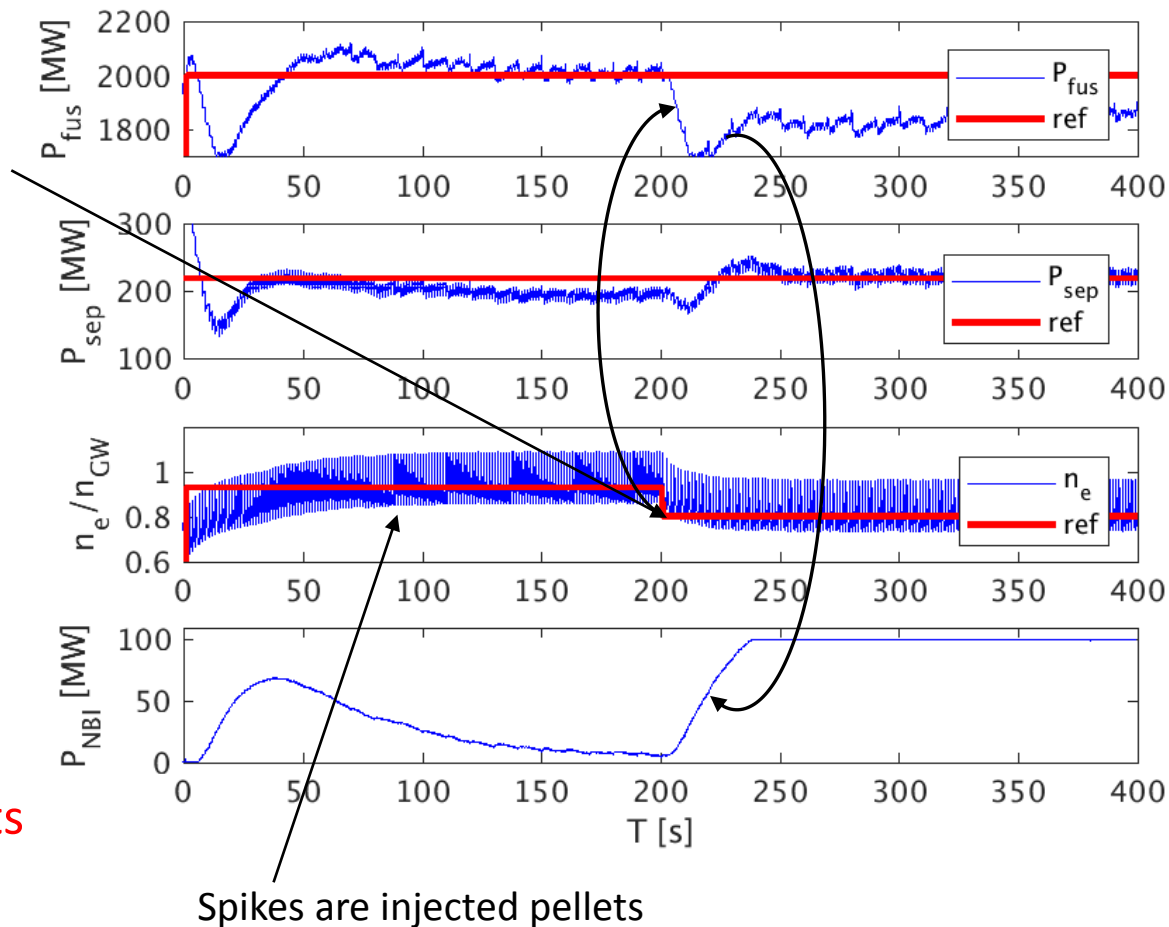

The control gains were chosen from the response of the measured quantity to the step command in the ideal case



Example: scan in pellet delivery failure rate

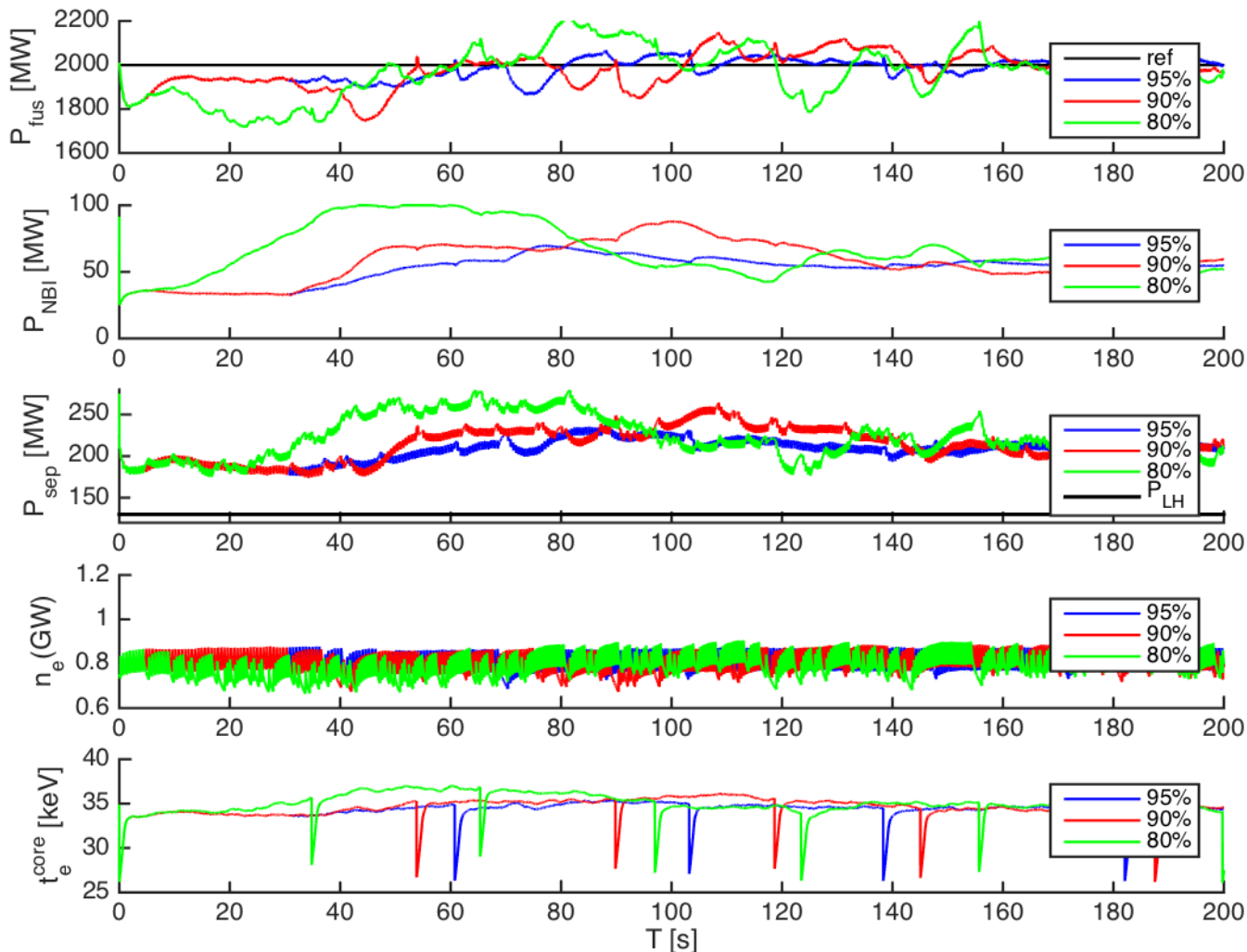

Success rate	P_{fus} std dev
95%	49 MW
90%	73 MW
80%	114 MW

Pellets with
3e21 p/pellet



Example: divertor temperature control

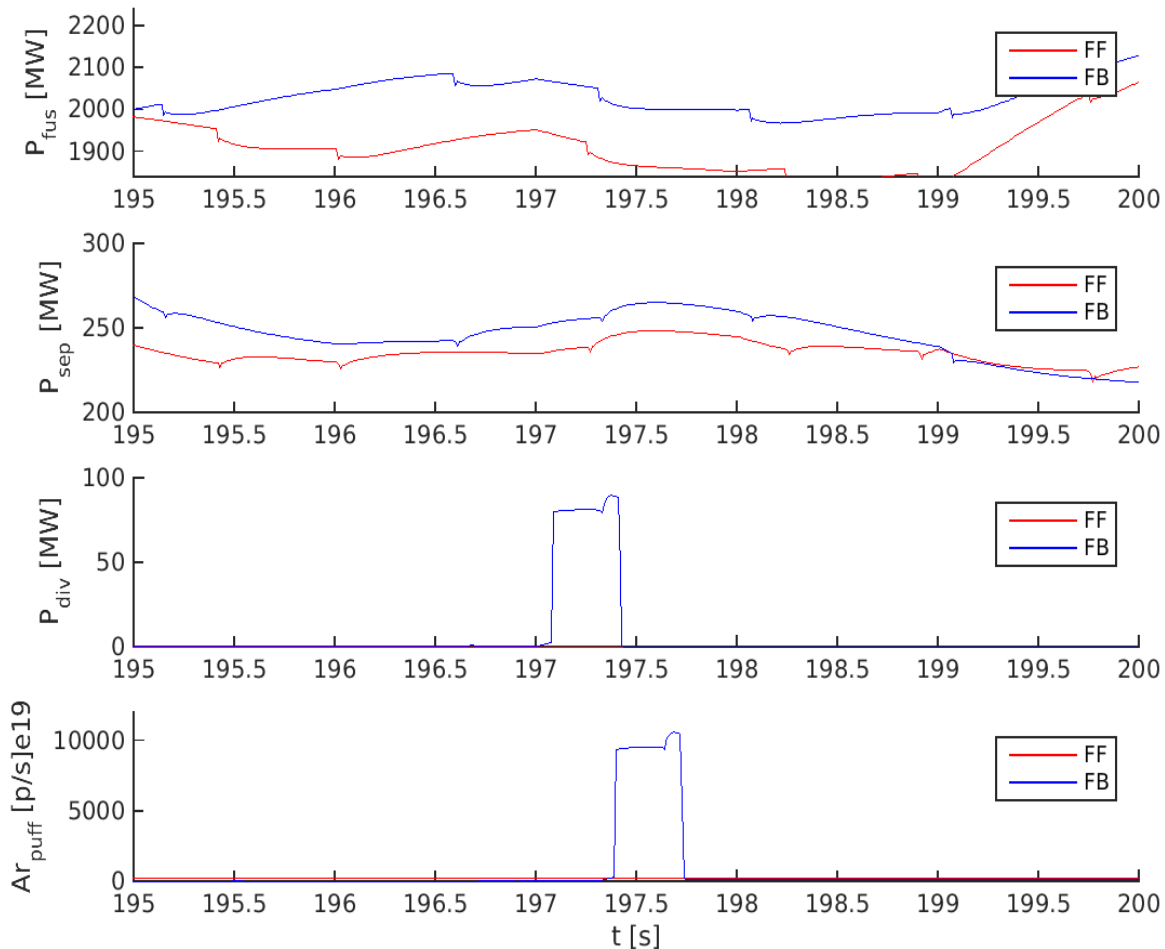

**2.2e21 Ar p/s
constant flow**

Options:

- Different **diagnostic**
 - detachment front
 - P_{sep}, C_{Ar}
- Different **control strategy** (non linear controller)
- **Sweeping** divertor (with diagnostics) – see later

More robust divertor model is important to investigate the involved timescales (not present at the moment).

Support from experiments?

Real values also depend on enrichment!



- This kinetic modelling and control work is important to
 - **Physical models** – test, compare and validate in present experiments
 - **Actuators** – estimate required power, efficiency, maximum delays
 - **Diagnostics** – estimate tolerable noise and required resolution
 - **Control** – investigate control strategies and controllability of scenario
- Caveat - explorative work
 - **More physical realistic models are necessary for quantitative studies (trends are captured)**



- Introduction
- ASTRA/Simulink integrated modelling
 - ❖ Model and assumptions
 - ❖ DEMO-related results
- **SOLPS modelling**
 - ❖ Fluid cases
 - ❖ Kinetic cases
 - ❖ Pumping
 - ❖ Synthetic diagnostics
- Divertor reattachment
 - ❖ Divertor reattachment in EU-DEMO
 - ❖ Impact on the machine design
- Conclusions





Fluid Cases

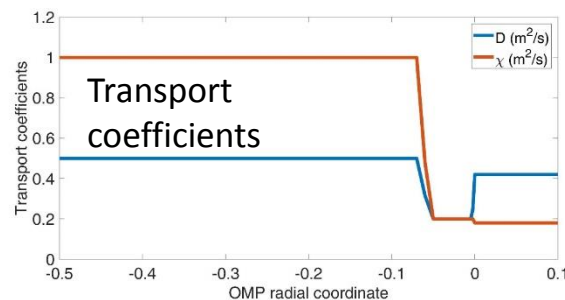
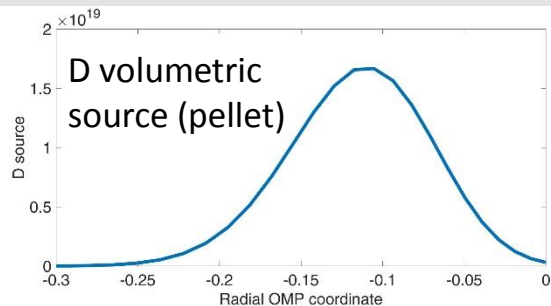
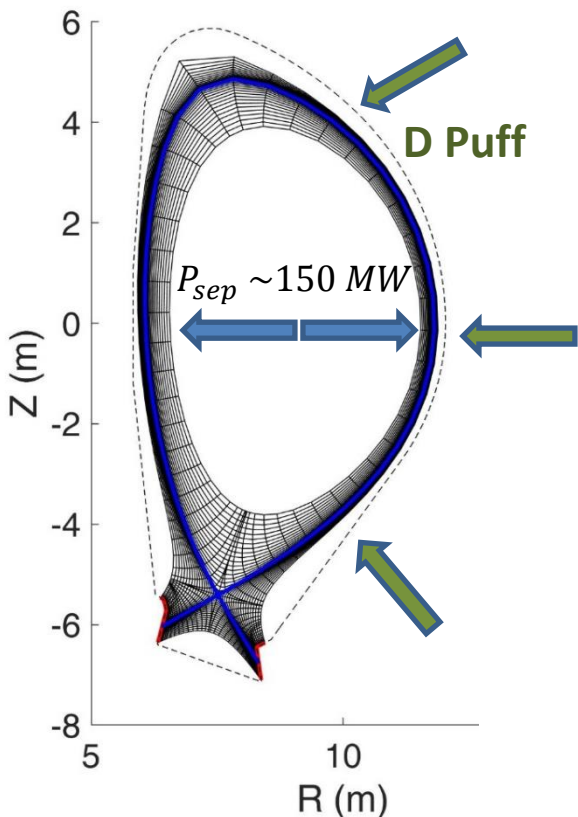

- Input power: $P_{sep} \sim 150 \text{ MW}$
- Particle input:
 - Pellet-like source
 - Puff from the wall
- Transport tuned for 3 mm SOL width
- Impurities:
 - Kr, N, Ne, **Ar, He**
 - No sputtering (W)
 - No drifts

Potentially strong implications:

- Large SOL n, T gradients \rightarrow drifts
- Need extreme radial resolution

Selected a two-step strategy:

- **Somewhat milder** estimate $\lambda_E \sim 3 \text{ mm}$
- Re-consider this point in the future

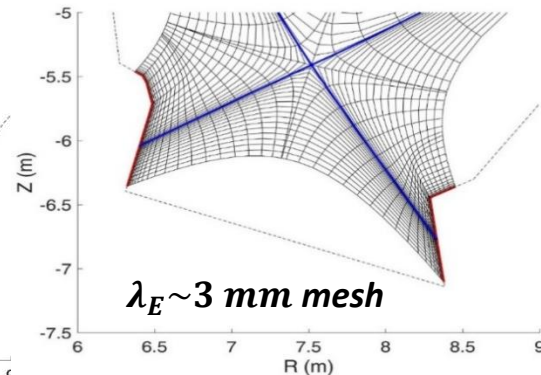
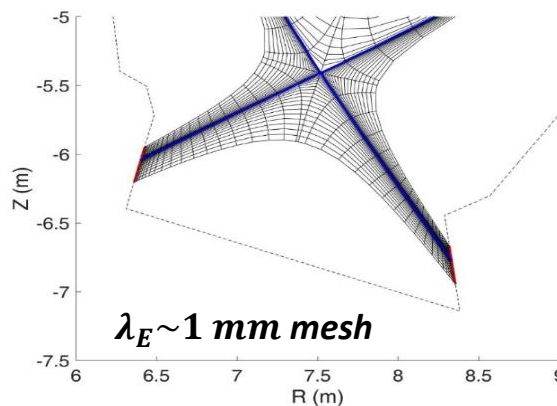



Kinetic Cases

Focus switched to kinetic-neutral modeling

- Pros:
 - Improved atomic physics
 - D_2 molecules
 - Neutral-neutral collisions
 - Improved divertor geometry
- **But slow** (several seconds plasma time for DEMO-size machine)
- Detailed analysis of **neutral distribution in the divertor region** now available
- **He accumulates close to strike points**, but present in the whole PFR
- D_2 preferentially goes to the **divertor corners**

ONLY ONE CONVERGED CASE AVAILABLE

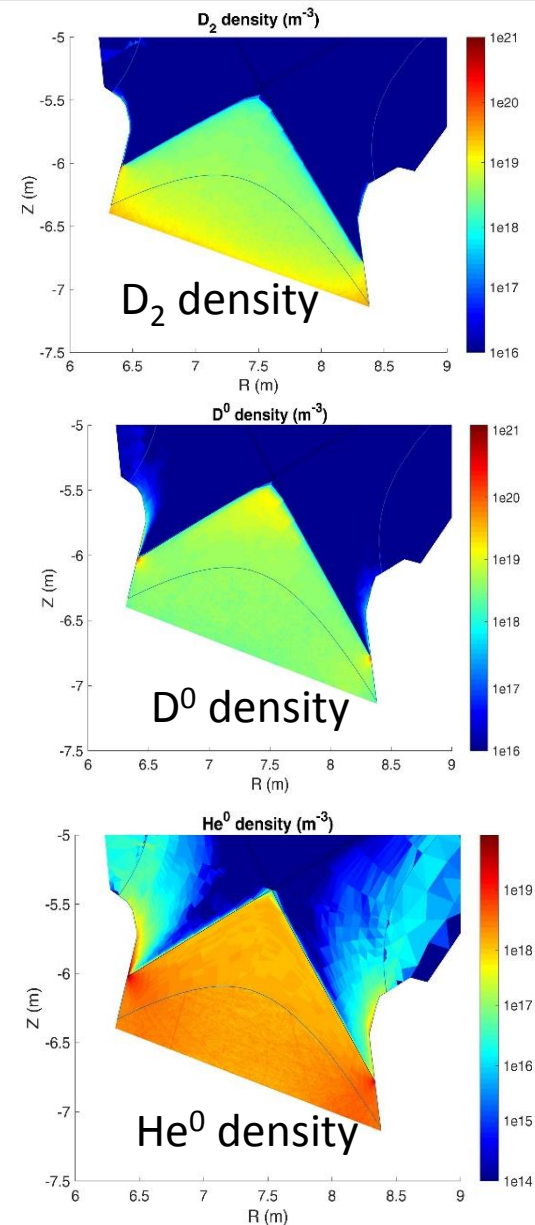



Pumping

[Poster Session III/11, presented by Yuri Igitchkanov]

SOLPS simulations are employed as boundary conditions for codes like **DIVGAS** or **ITERVAC** to evaluate the required capture coefficient ξ for an efficient He removal (and find an adequate technological solution).

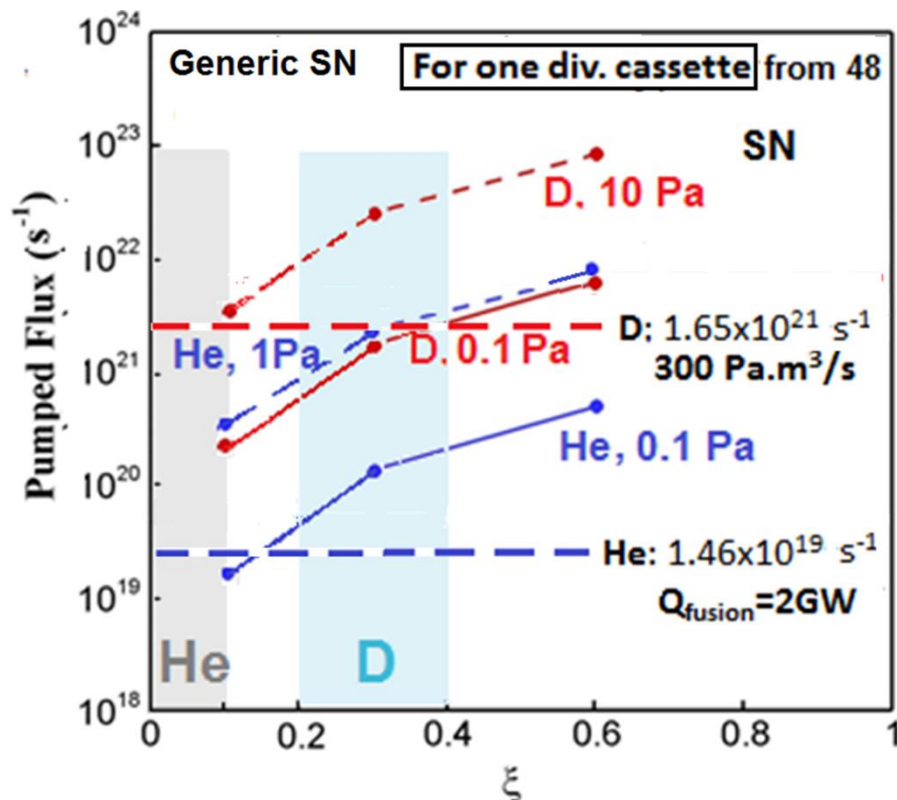
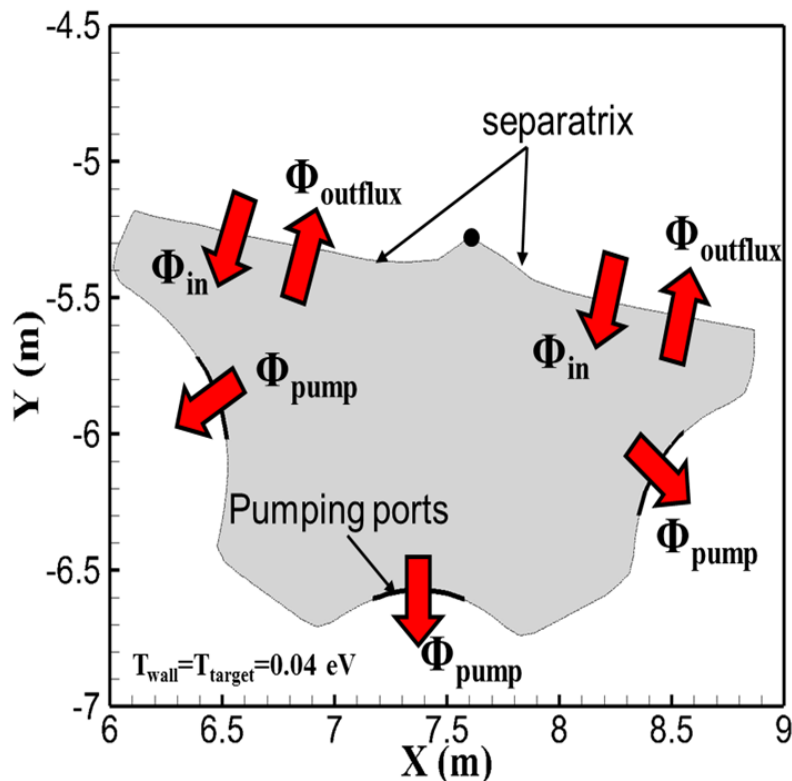

SOLPS modelling



Diagnostics

The implementation of *diagnostics* able to detect reattachment before it happens (e.g. *spectroscopy* – at least two toroidal locations) has been recognized as very important for EU-DEMO [Biel, FED 2019].

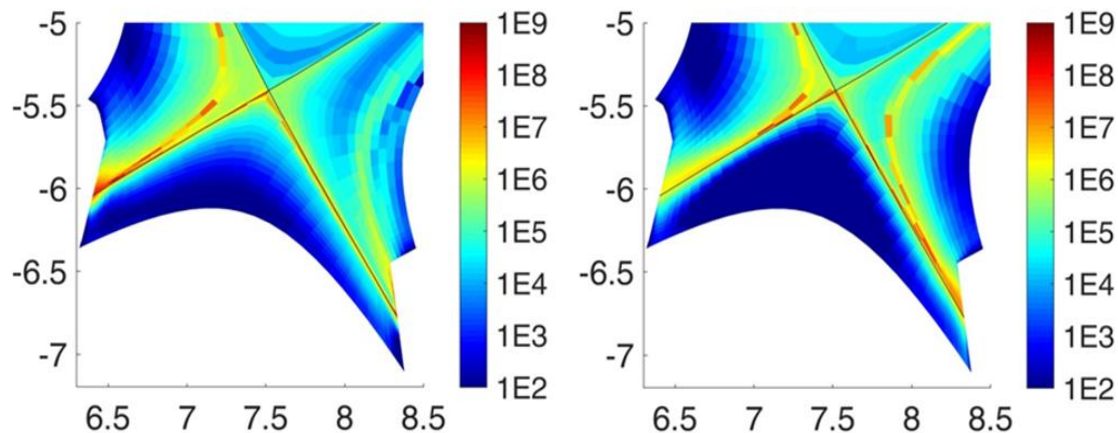

Concept validation ongoing.

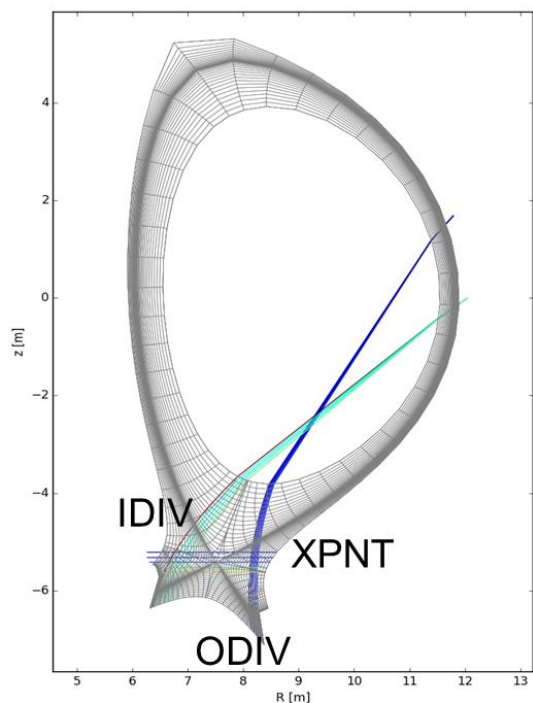

Δs = distance between LOS and separatrix

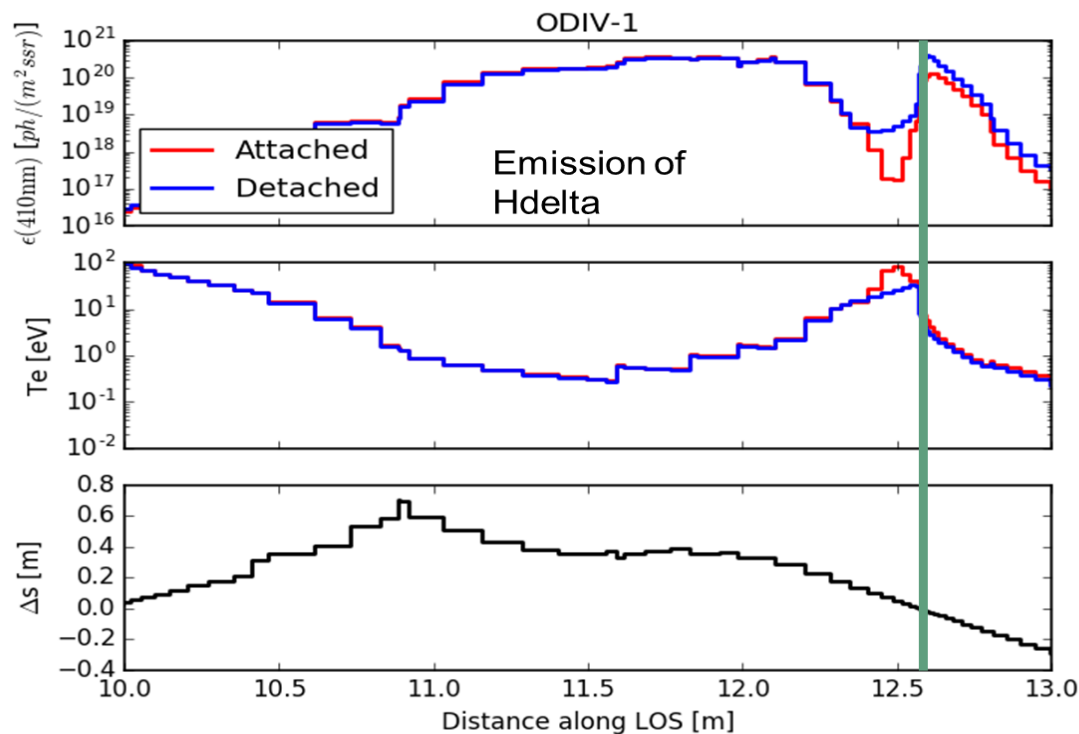



Diagnostics

Other diagnostics – e.g. **thermocurrent measurements** – are currently being developed.

Main (but not sole) issue there are the **forces** on the divertor structure due to the halo currents during VDEs.

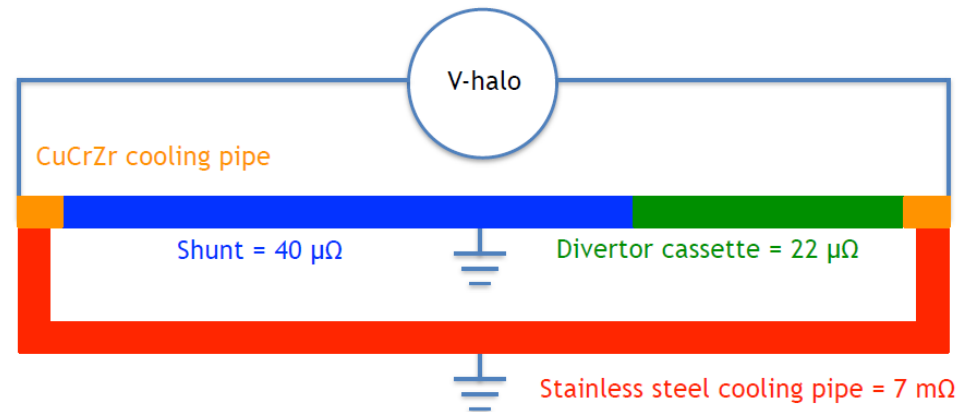
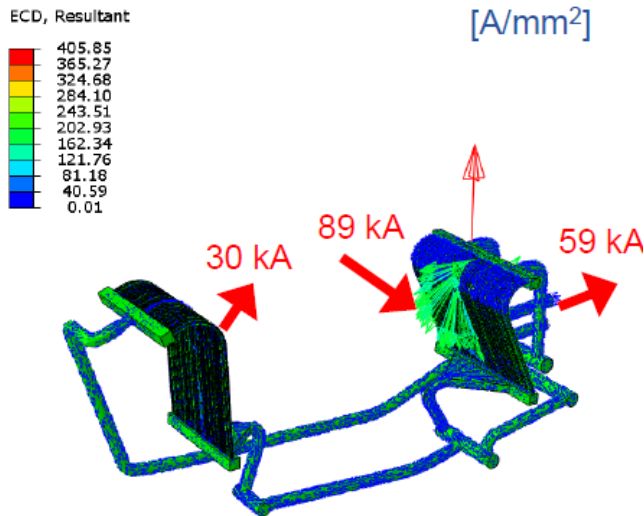
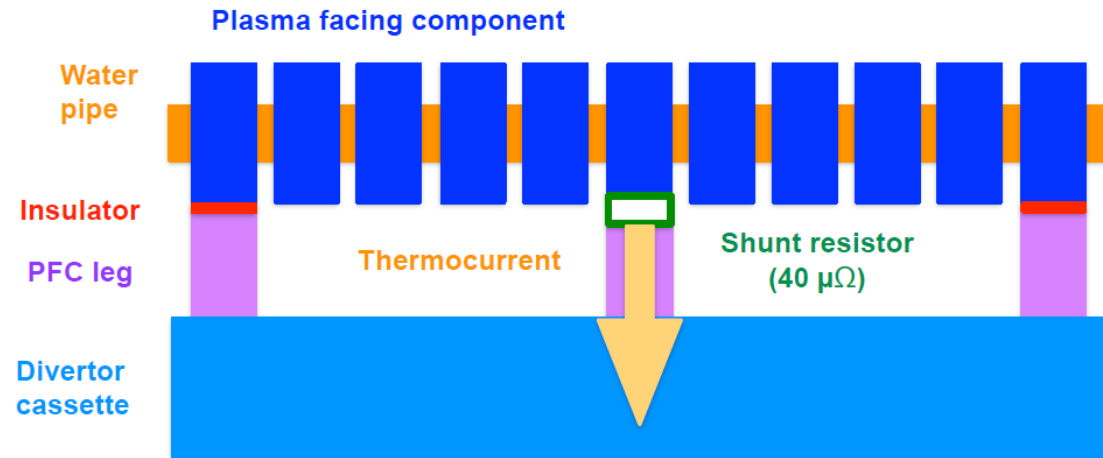



- Introduction
- ASTRA/Simulink integrated modelling
 - ❖ Model and assumptions
 - ❖ DEMO-related results
- SOLPS modelling
 - ❖ Fluid cases
 - ❖ Kinetic cases
 - ❖ Pumping
 - ❖ Synthetic diagnostics
- **Divertor reattachment**
 - ❖ Divertor reattachment in EU-DEMO
 - ❖ Impact on the machine design
- Conclusions



Divertor reattachment



A thin wall

- In contrast to ITER, DEMO possesses a **very thin first wall**, in order to allow tritium breeding.
- This thin wall can essentially not tolerate a contact with the plasma column (tiles misalignments).
- **Even the first-wall limiters** [F. Maviglia, ISFNT 2019] cannot withstand a contact at full current without being damaged.
- Simulations carried out with RAPTOR show that the plasma current **cannot be ramped down faster than $\sim 0.1 \text{ MA/s}$** without MHD instabilities appear.

In DEMO, there can be no controlled fast plasma termination

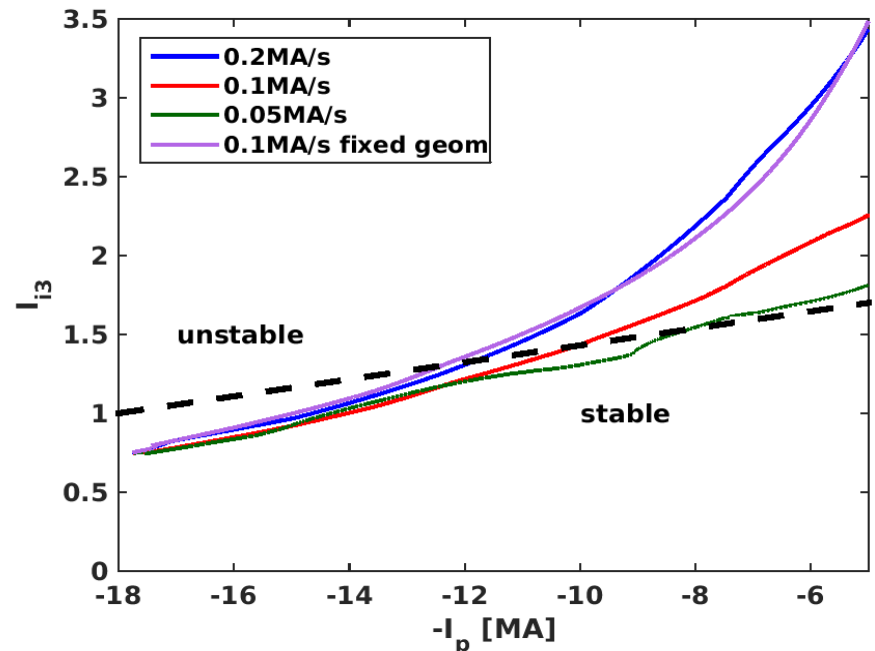
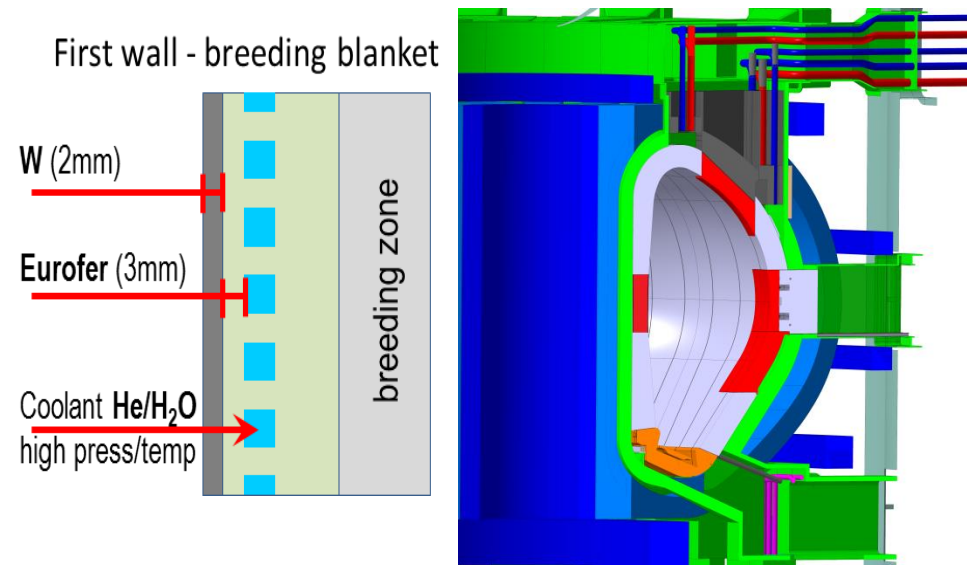



Divertor sweeping

How to protect the divertor during emergency current ramp-down in case of divertor reattachment?

In DEMO, it is foreseen to employ *divertor sweeping* (to be activated only in emergency cases) to allow the divertor surviving while the current is ramped down [Maviglia, FED 2016], [Siccinio, NF 2019].

HF ramp from 10 MW/m² to 70 MW/m² in 10 sec.

No Sweep
Sweep 10 cm 1 Hz
Sweep 20 cm 1 Hz

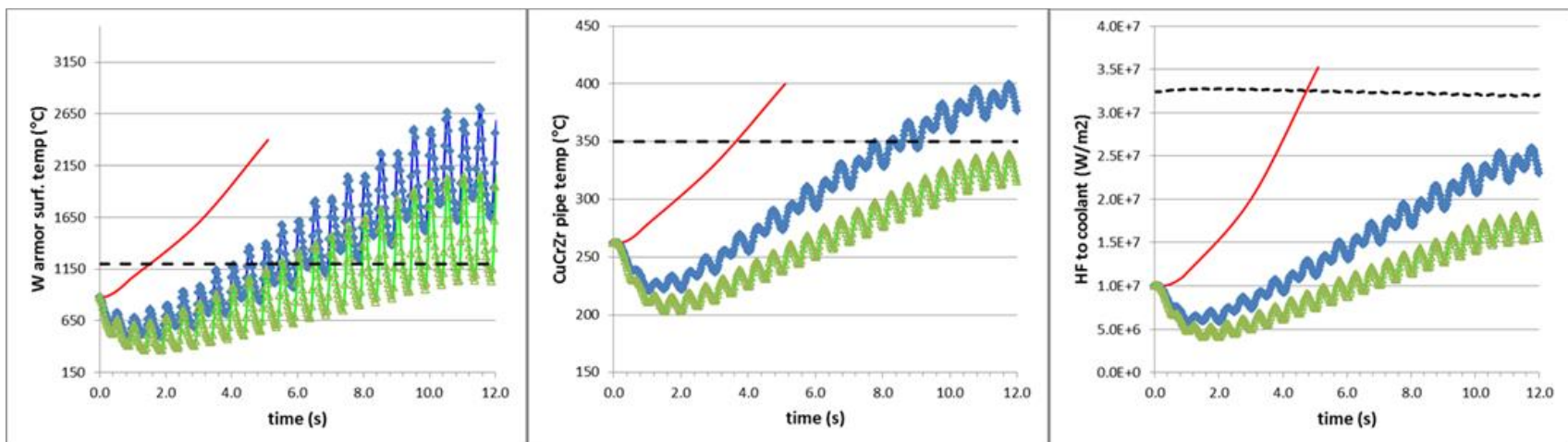
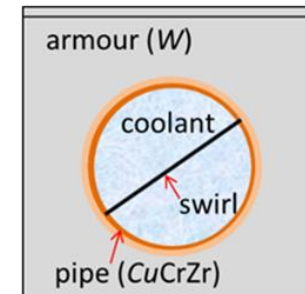



- Introduction
- ASTRA/Simulink integrated modelling
 - ❖ Model and assumptions
 - ❖ DEMO-related results
- **SOLPS modelling**
 - ❖ Fluid cases
 - ❖ Kinetic cases
 - ❖ Pumping
 - ❖ Synthetic diagnostics
- **Divertor reattachment**
 - ❖ Divertor reattachment in EU-DEMO
 - ❖ Impact on the machine design
- **Conclusions**





The divertor physics modelling for EU-DEMO follows **two different lines of study**:

- 1. Integrated modelling for dynamic simulations:** an integrated ASTRA/Simulink model is able to reproduce (in a simplified way) DEMO dynamic phases, and helps to identify criticalities that a steady-state analysis cannot catch.

Such analysis has shown the importance of an integrated approach, especially in a “non-linear” device like DEMO, where the plasma heating power strongly depends on the plasma condition itself.

No DEMO design process can forget about dynamic phases!

- 2. SOLPS simulations** for detailed understanding and input to engineering activities (e.g. dimensioning of the pump, development of synthetic diagnostics et cetera).

This activity will become of special importance in the forthcoming engineering phases.