

Development and testing results of water-cooled divertor target concepts for EU DEMO reactor

Third Technical Meeting on Divertor Concepts
IAEA Headquarters, Vienna, 4-7 November 2019

Presenter: Visca Eliseo, ENEA
Contributors: J.-H. You, H. Greuner, A. v. Muller

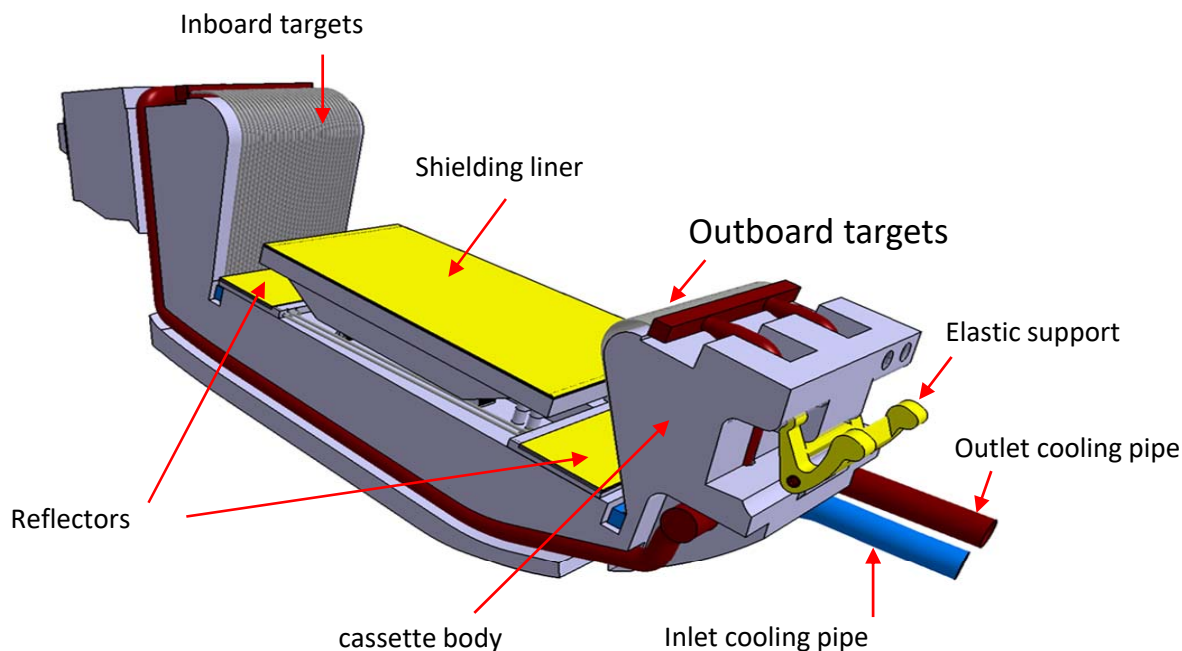



- ❖ Power to exhaust: 251 MW in total
 - Targets plates 138 MW
 - cassette body: 113 MW
- ❖ Peak heat flux on targets (122 MW)
 - stationary: 10 MW/m²
 - transient: 20 (10s) - 50 (< 0.5s) MW/m²

- Design criteria:
- 10 MW/m², nominal steady-state operation,
 - 20 MW/m², during slow transients up to 10 s
 - 150 ° C water inlet, 50 bar, 16 m/s
 - Applicable to a mass production of 625.000 W monoblocks arranged in ~ 70 cm long target units

- cassette body: Eurofer steel
- liner, reflectors: Eurofer steel (coated with tungsten)
- vertical targets: tungsten monoblock armor + copper alloy (or composite) pipe

- Expected neutron dose accumulated during 2 full power operation years:**
- **4 dpa in W, 13 dpa in CuCrZr cooling tubes**

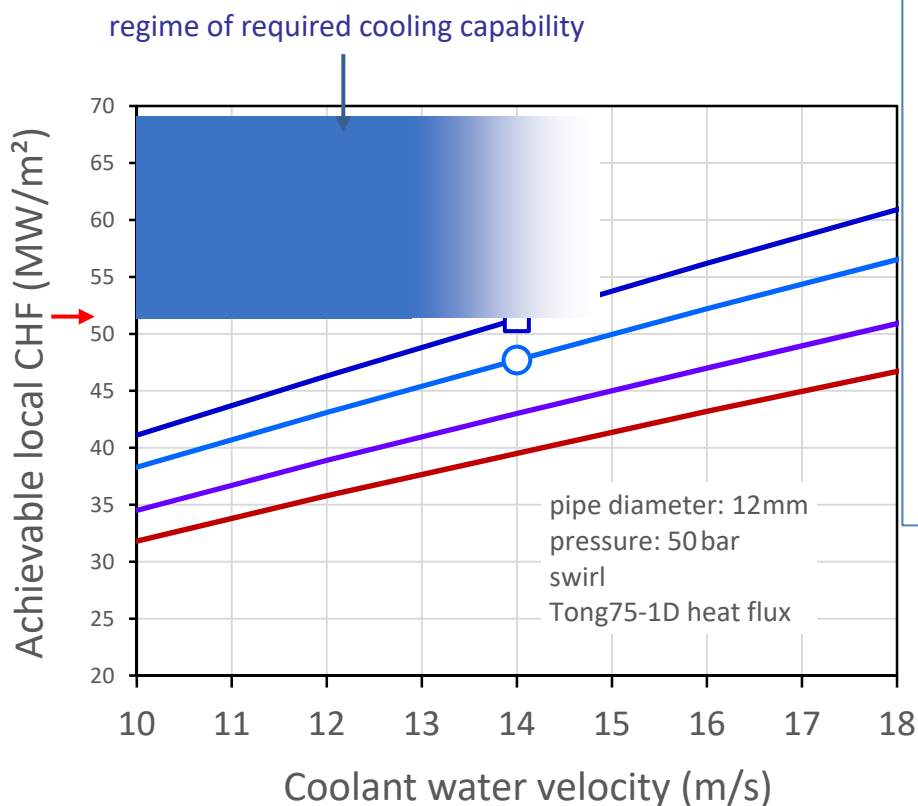

- ✓ Heat flux load (at the strike point)
 - surface heat flux (stationary): ~10 MW/m²
 - surface heat flux ('slow' transient): ~20 MW/m²
 - heat flux peaking factor: ~1.6
 - margin to the CHF: ~1.4
 - local critical heat flux: ~45 MW
- ✓ Cooling condition (at strike point)
 - Local bulk temperature: ≤140 °C
 - Coolant velocity: 14 m/s
 - Pressure (inlet): 5 MPa

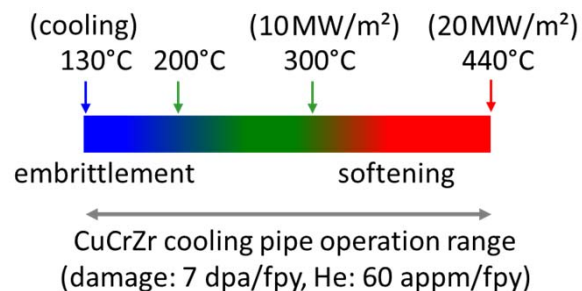

Divertor Project: PPPT-WPDIV

WBS 1 - Cassette Development

Design, neutron irradiation calculations, hydraulic, RH

WBS 2 - Target Development

- 1) explore the design feasibility of various Vertical Target concepts
- 2) optimize the target design and technology
- 3) evaluate the individual target concepts by means of HHF test on real mock-ups,
- 4) select the best candidates with regard to:
 - the power exhaust removal capability
 - structural reliability
 - manufacturing technology suitable for industrial scale
- 5) qualify medium size prototypes under HHF fatigue and transient thermal loads.

1st phase R&D activities

1. FEA for thermo-mechanical prediction and geometrical optimization
2. Mock-up fabrication
3. Non-destructive test (Ultrasonic ENEA-ULTRAS and SATIR-CEA)
4. Thermal fatigue tests in GLADIS cool (20° C) and hot (130° C) coolant temperature conditions (HHFT)
5. Post HHFT Non-destructive test (ENEA-ULTRAS and SATIR-CEA)
6. Post mortem destructive analysis (W, interlayer, pipe)

2nd phase R&D activities

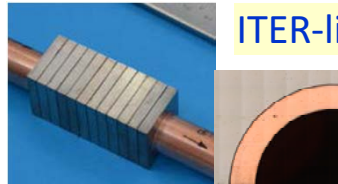

ITER-like

- ✓ Fabrication technology fully established.
- ✓ Mock-up production completed.
- ✓ High-heat-flux testing performed

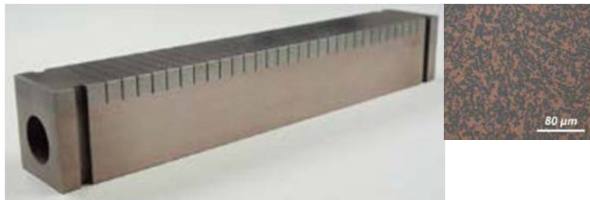

Composite block (W_p/Cu)

- ❖ **Baseline:**
 - tungsten mono-block type
- ❖ **Extra concepts:**
 - tungsten flat-tile type
 - Helium jet injection (dual pipes)

Thermal break



Composite pipe (W_f/Cu)

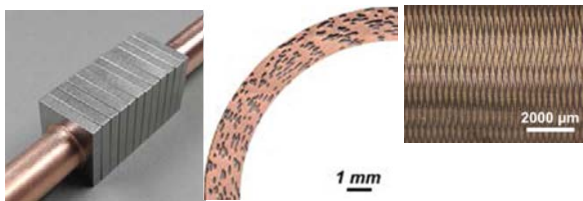

He jet injection (helium-cooled)



FGM- Functional Graded Material



Thin graded interlayer (W/Cu)

[23] New developments in the design of a helium-cooled divertor for the European DEMO

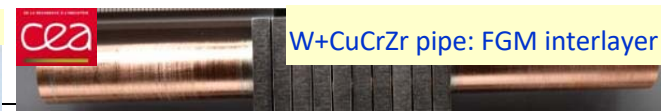
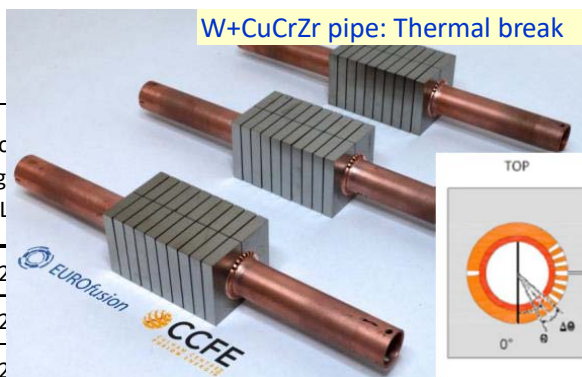
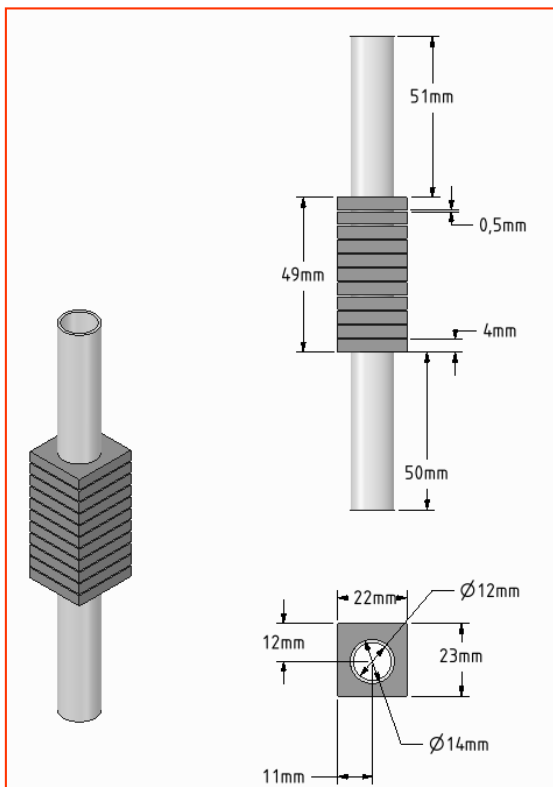

blocks lat	block thickness (t)	Block width (w)	block height (h)	Armour thickness (a)	Shoulder thickness (b)	Bottom thickness (c)	Interlayer thickness (e)
0	4	22	24	5	3	3	2
0	4	22	24	5	3	3	2

30	no	15	12	-	W	Flat
50	?	14	16	?	W	block, 4

W+Composite pipe (W_f/Cu): 1mm Cu-interlayer



W+CuCrZr pipe: ITER-like 1mm Cu-interlayer



				5	3	3	0,5
				7	6	7	0,5
				5	3	3	0,5
2	4	22	26,3	5	3	3	0,5

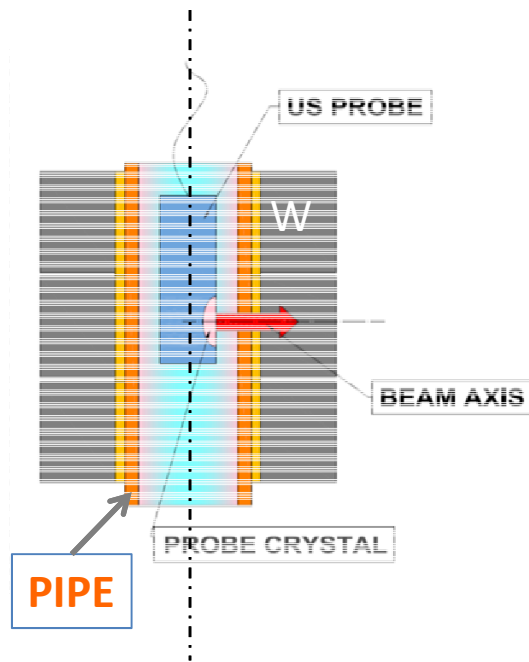

ULTRASONIC TECHNIQUE PRINCIPLE

- **ultrasonic** pulse-echo technique: the probe is placed in the bore of the CuCrZr pipe with water fill
- echo signal is acquired for specific radial penetration by axial scanning
- joined interfaces map created (unwrapped cylindrical map: c-scan)
- calibration by reference component with known defect size

SATIR: fast thermal solicitation of PFC to evaluate global thermal quality and thermal imperfection size

- Fast water cooling in pipe channel, abrupt variation of temperature (100° C to 10° C)
- Measurement of surface temperature by means of IR thermocamera
- Data treatment and thermal surface map analysis
- Identification, localization and sizing of thermal imperfection

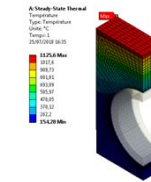
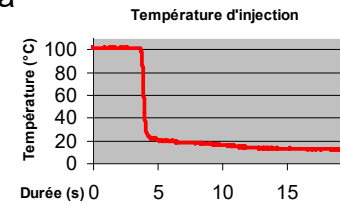
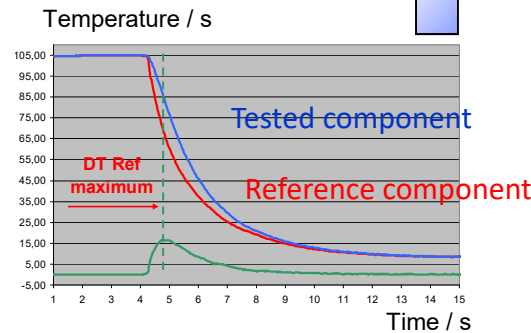
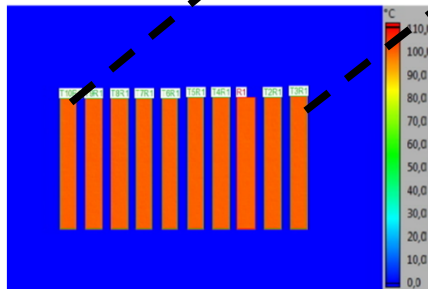
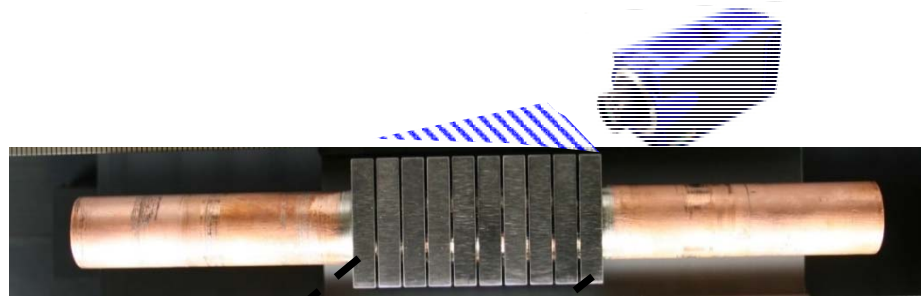

Finite element modeling

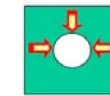
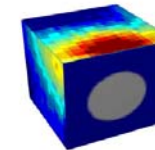

Geometric projection

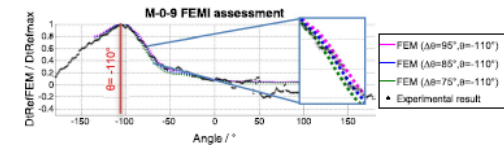

Figure 2. Normalized DtRef profiles obtained with finite element method (FEM) and with experimental data for monoblocks M0-1

Experimental validation of thermo-mechanical behaviour under DEMO relevant cyclic heat loads and cooling conditions

Aim: Identification of the most promising concept(s)

- cyclic heat loading in **GLADIS (hydrogen neutral beam facility)** to investigate fatigue and accumulation of plastic strain in materials

H. Greuner, 17th PFMC, 20.-24. May 2019, Eindhoven



Uniform test procedure and typically 3 mock-ups for concept:

1. Step (each mock-up): cold-water, low pressure (20 ° C inlet, 10 bar, 12 m/s) as “initial assessment”

1. screening up to 25 MW/m²,
2. 100 cycles 10 s at 10 MW/m² fatigue as quality assessment

2. Step: hot-water, higher pressure (130 ° C inlet, 40 bar, 16 m/s)

1. screening up to 20 MW/m²,
2. cycling up to 500 (1000) cycl. at 20 MW/m², 10 s (one mock-up of each concept)

3. Step: cold-water, high velocity (20 ° C inlet, 16 m/s) overload screening and fatigue tests

1. screening up to 32 MW/m², followed by 100 x 25 MW/m²

Rationale for step 3: to test thermal limits close to the collapse of heat transfer (CHF).

Considering a safety margin of 1.4, the heat flux on the components should be **limited to 22 MW/m² during hot water cooling.**

→ Therefore we performed the tests at **cold water** and coolant high velocity for a safe heat transfer up to 32 MW/m².

RU	Design concept	CuCrZr tube condition as received	CuCrZr tube supplier	W grade	Interlayer	Tube Joining techn.	Brazing alloy (if brazed)
CEA	FGM	SAA	Le Bronze	ALMT Japan	Graded W	HIP/brazed	
CCFE	TBCI-w27-split	SAA	Zollern	ALMT Japan	OFE Cu, Machined	brazing	CuAu
CCFE	TBCI-w22-split				OFE Cu, Machined		
KIT	Flat W laminate (DB)			ALMT Japan	OFE Cu	D. bonding	
IPP	W-Composite (particulate/flat)	SAAWcD	KME-DE	ALMT Japan		brazing	CuAu
	W-Composite (W-fibre, monoblock)			ALMT Japan			brazing
ENE A	DEMO (4 mm W)			ALTM+AT&M	HRP		
	ITER-Optimized (12 mm W)			ALTM+AT&M			
	ITER-WPMAT x 1	KIT (PIM)					

Grade CRM16 TER = Tempered Stretched Annealed
ELBRODUR-HF

Design concept	Comp.	NDT		COLD WATER - 20°C, 1 MPa, 12 m/s				
		Ultrasonic	SATIR	A -screening cold water 20 MW/m ²	B, 100 x 10 MW/m ²	C, 100 x 15 MW/m ²	D, overload 25 MW/m ² screening	E, overload +100 x 20
TBCI-w27-split	#001	OK	OK	OK	OK		OK	
	#002	OK	OK	OK	OK			
	#003	OK	OK	OK		OK		
TBCI-w22-split	#004	OK	OK	OK		OK		
	#005	OK	OK	OK	OK			
	#006	OK	OK	OK	OK			
Flat tile-KIT	no. ?			failed				
Flat tile-KIT HIP	H20 V 21			failed				
Flat tile-KIT HIP	H20 V 31			only 17MW/m ²		failed, #76		
FGM	#3	OK	OK	OK	OK		OK	
	#4	OK	OK	OK	OK		OK	
	#5	OK	OK	OK		OK		
	#6	1	1	OK	OK			
	#1	OK	OK	OK		OK	OK	
	#2	two defective outer tiles		-	-	-		
DEMO opt	#005	OK	OK	OK	OK			
	#007	12	12	OK	OK			
	#008	1,11,12	1,11,12	OK				
ITER-Optimized	#009	OK	OK	OK		OK		
	#011	OK	OK	OK	OK			
	#012	OK	OK	OK	OK			
W-Composite	#1			OK				failed #362
	#2			OK				OK
	#3			22 MW/m ² , failed				
Wfibre CuCrZr tube				OK				
WfCu Monoblock	#1	OK		OK	OK			

Design concept	Comp.	NDT		HOT WATER 130°C, 4 MPa, 16 m/s					Result hot water tests
		Ultrasonic	SATIR	Screening 20 MW/m ²	100 cycl 10 MW/m ²	100 cycl 15 MW/m ²	100 cycl 20 MW/m ²	300 cycl 20 MW/m ²	
TBCI-w27-split	#001	OK	OK	OK			OK	STOP	degrad. of upper blocks, stop after cycl.150 1)
	#002	OK	OK						mup not selected for hot water tests
	#003	OK	OK	OK	OK	OK		PASSED	o.k., strong surface modification visible
TBCI-w22-split	#004	OK	OK						mup not selected for hot water tests
	#005	OK	OK	OK			PASSED		o.k., Swagelok damaged
	#006	OK	OK	OK			OK	PASSED	o.k. increase of Tsurf lam 2-5 lower central part, only minor surf. modification visible 2)
Flat tile-KIT	no. ?								based on cold water results,mup not tested
Flat tile-KIT HIP	H20 V 21								based on cold water results,mup not tested
Flat tile-KIT HIP	H20 V 31								based on cold water results,mup not tested
FGM	#3	OK	OK						mup not selected for hot water tests
	#4	OK	OK	OK			OK	PASSED	o.k., continous increase of Tsurf centre blocks 5-7 during cycling (IR ananlysis) 3)
	#5	OK	OK	OK	OK	OK	PASSED		100 x 10MW/m ² , 100x15MW/m ² , o.k
	#6	1	1						based on cold water results,mup not tested
	#1	OK	OK						
	#2	two defective outer tiles							
DEMO opt	#005	OK	OK	OK			OK	PASSED	o.k. no visible degradation
	#007	12	12						based on cold water results,mup not tested
	#008	1,11,12	1,11,12						based on cold water results,mup not tested
ITER-Optimized	#009	OK	OK						
	#011	OK	OK	OK			OK	PASSED	o.k., strong surface modification block swelling visible after ~200 cycl.
	#012	OK	OK						
W-Composite	#1								Mup not suitable for hot water cooling
	#2								Mup not suitable for hot water cooling
	#3								Mup not suitable for hot water cooling
Wfibre CuCrZr tube									only tube, not tested
WfCu Monoblock	#1	OK		OK			OK	PASSED	o.k. no visible degradation

1st phase - HOT-WATER, 500 cycles @ 20 MW/m²

W-armor: 5 mm

ITER-like ENEA #11

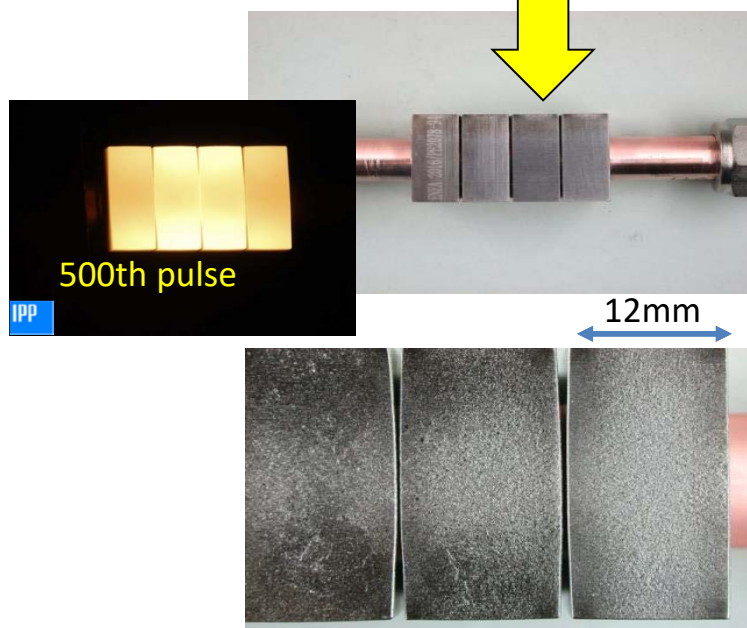

DEMO ENEA #5

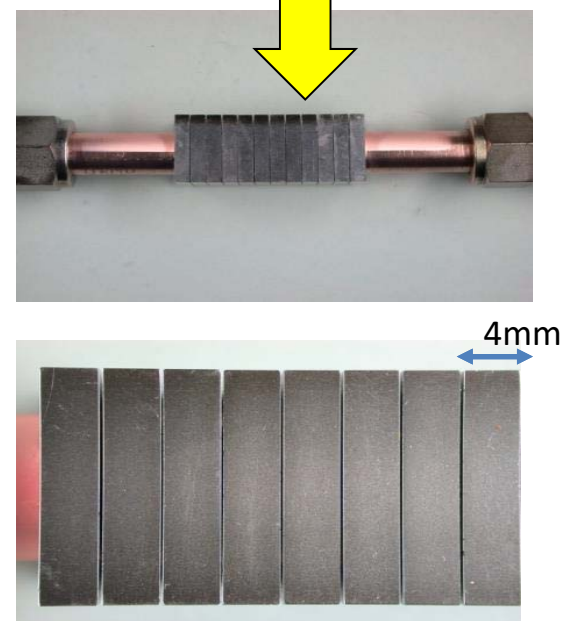

12.10.2018

39 blocks of 11 mock-ups
 Selection of **damaged and undamaged blocks** after HHF tests

	Mock-up	Maximum heat flux	Cut	Blocks	Cut	Analysed	Reported
Iter-Like	CCFE#3	300x20 MW/m ² hot water	Axial & transversal IPP	CCFE#3-2	X		
				CCFE#3-7	X		
	CCFE#5	100x20 MW/m ² hot water	Transversal CEA	CCFE#5-3	X	X	X
	CCFE#6	300x20 MW/m ² hot water	Axial & transversal IPP	CCFE#6-4	X		
				CCFE#6-8	X		
				CCFE#6-9	X		
				CCFE#6-10	X		
	ENE#5 (CASTING)	500x20 MW/m ² hot water	Axial cutting in IPP then Transversal cut in IPP/CEA	ENE#5-1 and #5-11	X	X	X
				ENE#5-12	X		
	ENE#7 (HIP)	100x20 MW/m ² cold water	Transversal CEA	ENE#7-2	X	X	X
ENE#8 (CASTING)	Scr. at 20 MW/m ² cold water	Transversal CEA	ENE#8-2	X	X	X	
			ENE#8-8	X	X	X	
ENE#11 (HIPING)	300x20 MW/m ² hot water	Axial cutting in IPP then Transversal cut in IPP/CEA	ENE#11-1	X			
			ENE#11-2	X			
			ENE#11-3	X			
			ENE#11-4	X			
CEA#2	1000x20 MW/m ² 500x20 MW/m ² Cold water	Transversal JULICH	CEA #2-4	X	X	X	
			CEA #2-7	X	X	X	
			CEA #2-8	X	X	X	
CEA#4	500x20 MW/m ² hot water	Axial cutting in CEA then Transversal cut and analysis in IPP/CEA	CEA#4-2	Sent to IPP 01.08	Sent to IPP 01.08	Sent to IPP 01.08	
			CEA#4-5	Sent to IPP 01.08	Sent to IPP 01.08	Sent to IPP 01.08	
			CEA#4-6	X	X	X	
			CEA#4-10	X	X	X	
CEA#6	100x20 MW/m ² Cold water	Transversal CEA	CEA #6-10	X	X	X	
IPP#1	500x20 MW/m ² hot water	Axial & transversal IPP	IPP#1-4 → IPP#1-9	??	??	??	

1. Undamaged block taken from mock-up with min of solicitation
2. Undamaged block of a mock-up after hot water HHF tests
3. Mock-up used as a reference for SATIR (DTref~5°C)
4. Mock-up used to understand defect detected with UT
5. Damaged block(s) due to hot water HHF tests

Metallographic examination + NDT and HHF correlations
 to define NDT reliability nature of thermal imperfection

Analyzed mock-ups which sustained
500c@20MW/m² :
CCFE#6 ENE#5 CEA#4 IPP#1

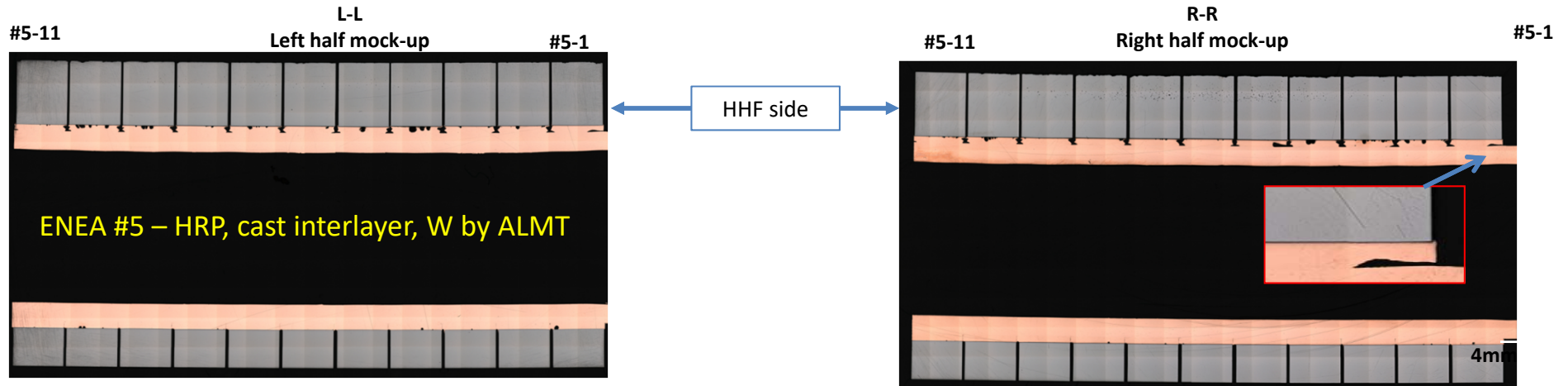

Conclusion:

- ➔ No modification and deep cracks in W HHF-surface
- ➔ Damages concentrated in the interlayer:
 - 1) voids in cast joints for 6 of 11 blocks
 - 2) increased number of voids due to HHF tests
- ➔ Good agreement with NDT (ENE A-ULTRAS)



Remark: results of metallographic analysis after 500c @20MW/m² hot water



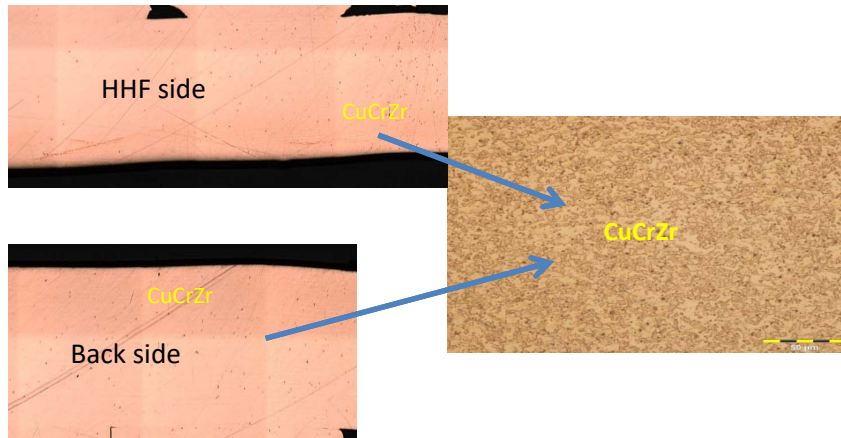

Micro-hardness 116 (HV 0.3)

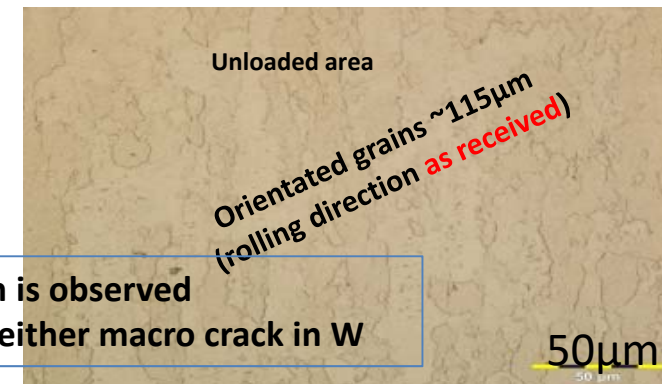
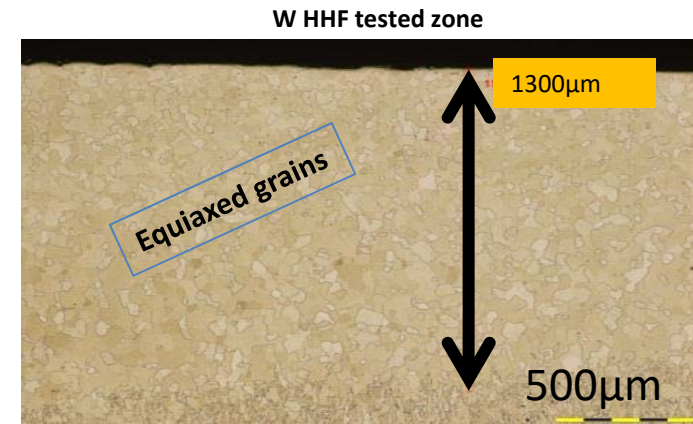

Conclusion:

- CuCrZr pipe keeps its fine grains aspect
- No softening of CuCrZr

- W recrystallization is observed
- No major defect neither macro crack in W

Summary

- 1st Phase HHF completed with very good results
- 300 cycles at 20 MW/m² hot-water of all W monoblock concepts successfully performed
 - good agreement between FEM predicted and measured surface temperatures
 - Indication of recrystallization and grain growth of W surface after 500 cycles at 20 MW/m²

Outlook

- NDT performed before and after HHF loading
- Micrographs of selected mock-ups
 - Investigation of recrystallization depth, grain size
 - Investigation of W/Cu interface, plastic deformation, delamination, cracks

Conclusion

- **European labs are able to produce advanced W divertor water-cooled PFCs for DEMO application. These components withstand up to 20 MW/m² cyclic heat load**
- **Important R&D progress in the last years, improvements are still possible**
- **Standard mock-up geometry is required to enable concept comparison**

Started begin 2017 and concluded in 2018

Standardized pipe and W-block dimensions for all design-concepts under development

- ✓ Surface W thickness ≥ 8 mm (erosion)
- ✓ Pipe wall thickness 1.5 mm (corrosion)
- ✓ W-block axial dimension 12 mm
- ✓ W-block width ~ 23 mm
- ✓ 4 W-blocks for mock-up
- ✓ Gap among W-blocks 0,5 mm

Final HHFT @ 20 MW/m²

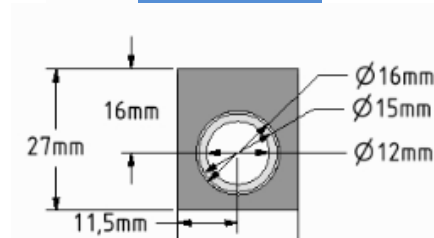
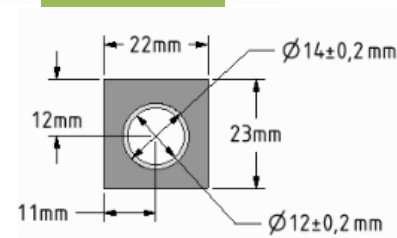
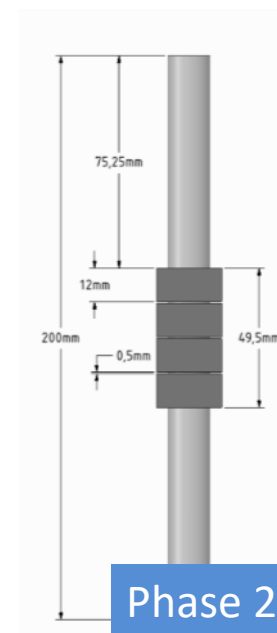
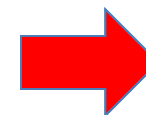
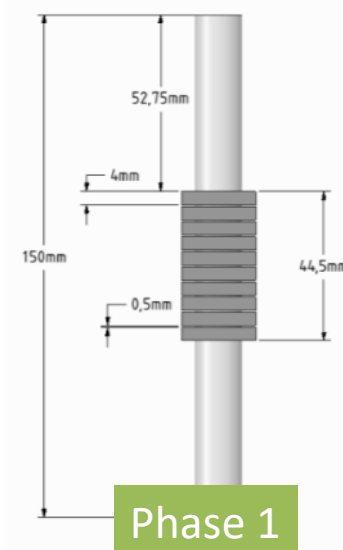

1st R&D phase

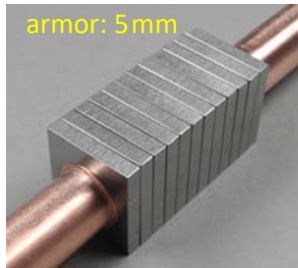

armor: 5mm

23 × 25 × 4 (mm³)

2nd R&D phase



armor: 8mm

23 × 28 × 12 (mm³)

ITER-like
(Cu interlayer: 1mm)

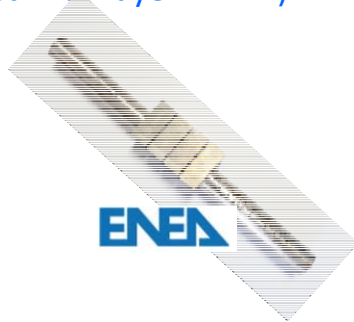

Thermal break
(+vertical notch)

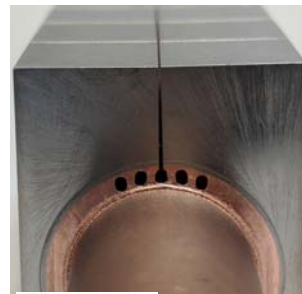

Composite pipe
(W-wire + Cu matrix)

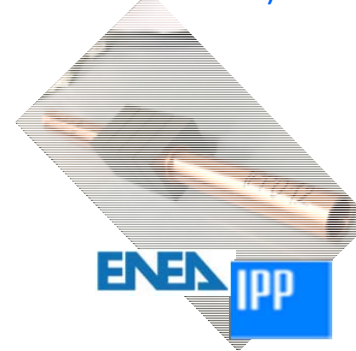
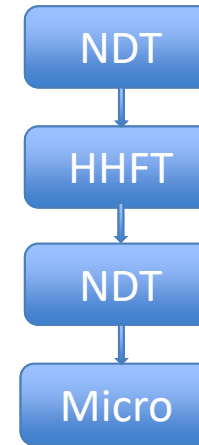
FGM- Graded interlayer
(W/Cu: 20μm, 400μm)

Investigation of different interlayer thicknesses

	Design concept	Amount of mock-ups (cores/mm)	Type block	n	Date	Technique
ENEA	ITER LIKE (AT&M)	3	AT&M 1mm Cu	16	30/11/17	HRP
				23	01/02/18	HRP
				24	19/02/18	HRP
ENEA	ITER LIKE (ALMT)	3	ALMT 1mm Cu	25	11/04/18	HRP
				28	24/04/18	HRP
				29	27/04/18	HRP
ENEA	25 micron Cu coating by CEA	2	AT&M	30	10/07/18	HRP-Failure
ENEA	100 micron Cu	2	AT&M	31	01/08/18	HRP-Failure
				20	17/01/18	HRP
				21	17/01/18	HRP
ENEA	300 micron Cu	2	AT&M	22	30/01/18	HRP-Failure
				26	18/04/18	HRP
				18	20/12/17	HRP
ENEA	W-Fibre Composite	3	AT&M 1mm Cu	19	12/01/18	HRP
				27	20/04/18	HRP
				5	06/03/18	CuAu
ENEA-IPP	W-Fibre Composite	3	AT&M 1mm Cu	10	07/03/18	CuAu
				12	10/05/18	CuAu
				14	04/10/18	CuAu
IPP	W-Particulate Cu	3	? flat			
CEA	20 micron Cu-HIP	2	AT&M 2016	7	17/11/17	PVD+HIP
				8	17/11/17	PVD+HIP
				9	17/11/17	PVD+HIP
CEA	FGM thin	2	AT&M 2016	10	17/11/17	PVD+HIP
				14	18/10/18	PVD+HIP
				15	18/10/18	PVD+HIP
CEA	FGM 500µm	2	AT&M 2016 and AT&M 2018	11	20/06/18	CS+HIP
				12	20/06/18	CS+HIP
				13	20/06/18	CS+HIP
CCFE	Thermal break	4	4off ALMT	7	04/06/18	CuAu Braze
				8	25/06/18	CuAu Braze
				9	25/06/18	CuAu Braze
				10	25/06/18	CuAu Braze
KIT	Flat/saddle tile	3		1 tile	01/06/18	HIP
				2 tiles	01/06/18	HIP
				4 tiles	01/06/18	HIP
				1 tile	01/06/18	HIP
				2 tiles	01/06/18	HIP
				4 tiles	01/06/18	HIP

	Design concept	Type W block	#	UT ENEA Results	SATIR Results	GLADIS Arrived		
ENEA	ITER LIKE (AT&M)	AT&M 1mm Cu	16	OK	Thermal imperfection block 1	12/04/18		
			23	OK	No thermal imperfection	12/04/18		
			24	OK	OK (Ref)	12/04/18		
ENEA	ITER LIKE (ALMT)	ALMT 1mm Cu	25	OK	No thermal imperfection	25/06/18		
			28	OK	OK (Ref)	25/06/18		
			29	OK	No thermal imperfection	25/06/18		
ENEA	25 micron Cu coating by CEA	AT&M	30	Failure during manufacturing				
			31					
ENEA	100 micron Cu	AT&M	20	NC to UT	Thermal imperfection block 4	10/07/18		
			21	OK				
			22	Failure during HRP				
			26	OK			No thermal imperfection	10/07/18
ENEA	300 micron Cu	AT&M	18	NC	No thermal imperfection	25/06/18		
			19	OK				
			27	OK			OK (Ref)	25/06/18
ENEA-IPP	W-Fibre Composite	AT&M 1mm Cu	5	NC	Thermal imperfection all blocks	25/06/18		
			10	OK			OK (Ref)	25/06/18
			12	OK			Thermal imperfection all blocks	25/06/18
			14	Small defect at block #2			Thermal imperfection all blocks	22/10/18
IPP	W-Particulate Cu	?						
CEA	20 micron Cu-HIP	AT&M 2016	7	OK	OK (Ref)	04/06/18		
			8	NO #4 (inside W)	Thermal imperfection block 4	22/02/18		
CEA	FGM thin	AT&M 2016	9	OK	OK (Ref)	22/02/18		
			10	NO- All (inside W)	Thermal imperfection all blocks	22/02/18		
		AT&M 2018	14	large defect at block 1	Thermal imperfection block 1	14/11/18		
			15	ok	OK (Ref)	14/11/18		
CEA	FGM 500µm	AT&M 2016 and AT&M 2018	11	N#2 detached at Cu/W	Thermal imperfection block 2	28/11/18		
			12	N#2-small defect	OK (Ref)	28/11/18		
			13	N#2 #3 detached at Cu/W	Thermal imperfection blocks 2 & 3	28/11/18		
CCFE	Thermal break	4off ALMT	7	ok	OK (Ref)	26/07/18		
		4off ALMT	8	ok	No thermal imperfection	26/07/18		
		4off ALMT	9	ok	No thermal imperfection	26/07/18		
		4off ALMT	10	ok	No thermal imperfection	26/07/18		

ITER-like (2nd phase, W: 8mm), W: AT&M -> 32 MW/m² (5 pulses) + 25 MW/m² (100 pulses)

Cu interlayer: 0.1 mm

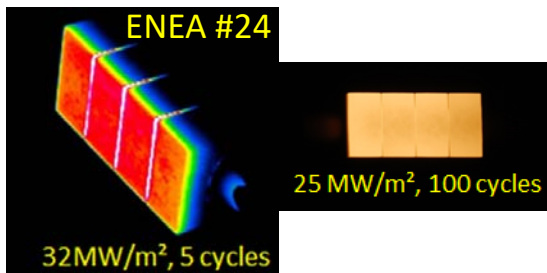

Cu interlayer: 0.3 mm

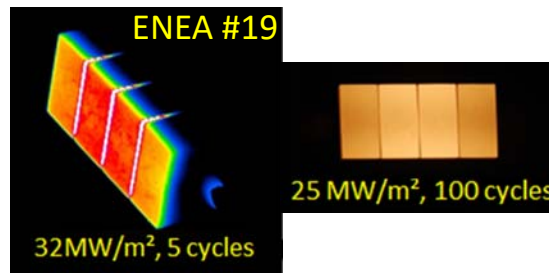

Cu interlayer: 1 mm

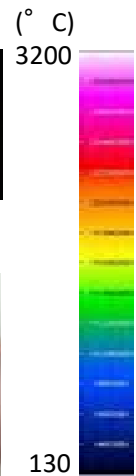
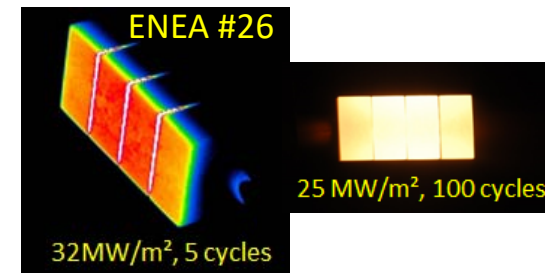

No cracks, intact joint in all cases

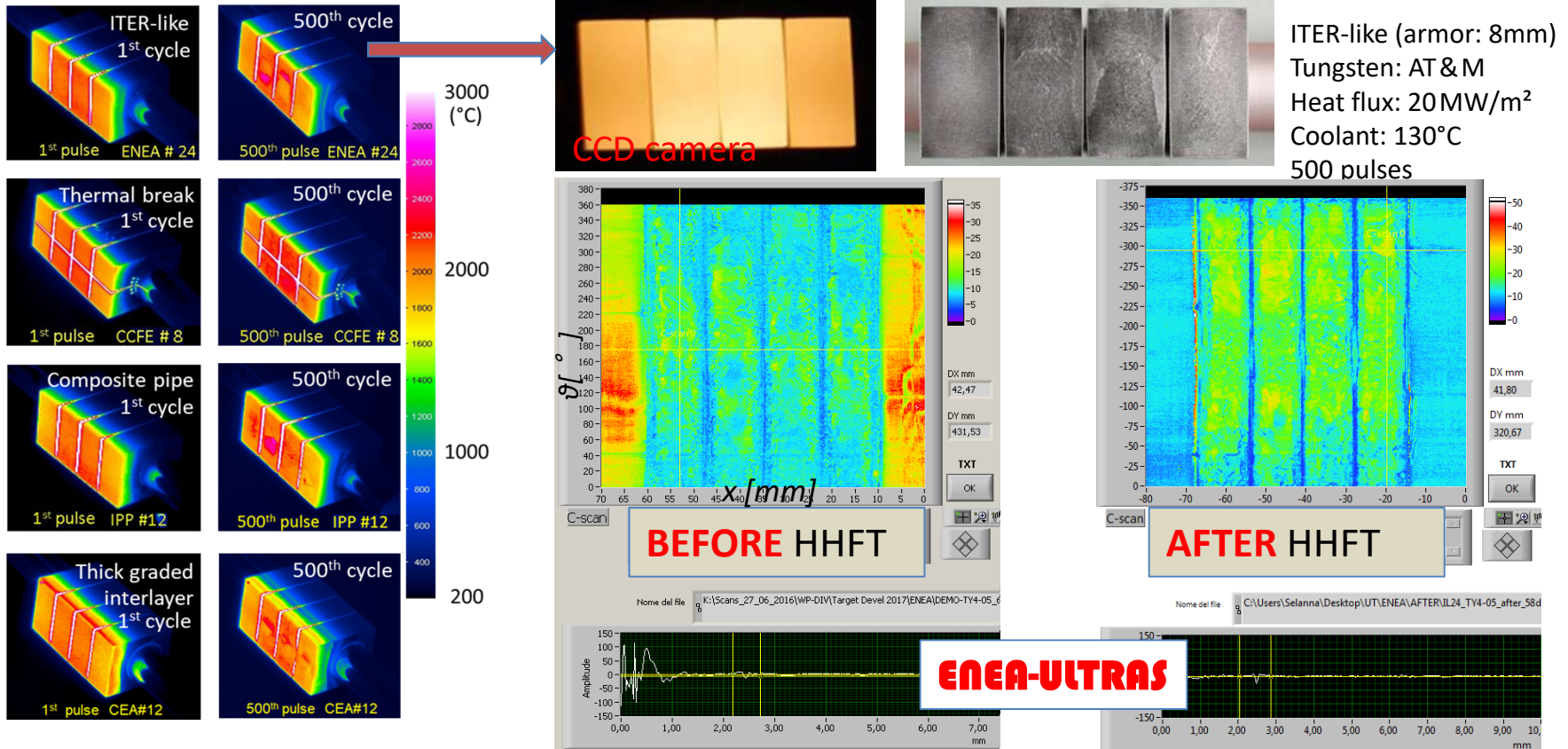

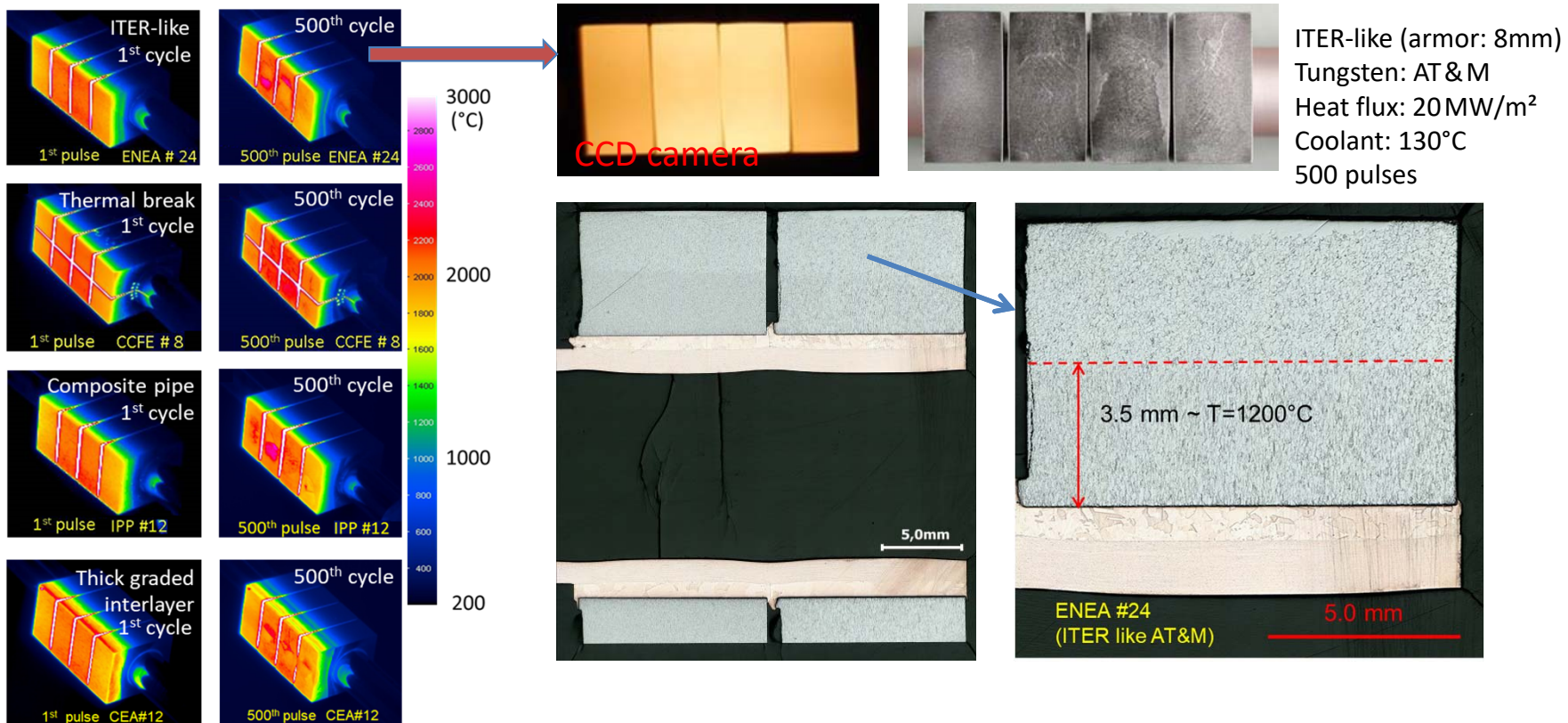

Summary

- 1st and 2nd R&D phases completed with very good results in agreement with calculations
- R&D activities performed for all concepts to improve reliability and performances
- NDT performed before and after HHF loading of all W monoblock concepts
- HHF testing campaign completed for all concepts

Conclusion

- Only slight differences in the HHF behavior due to the concept design solution adopted
- Important outcome R&D progresses for novel technologies (W/Cu composites for heat-sink and pipes, FGM interlayer, new ENEA-HRP furnace,)
- No critical damage features found (no armor cracking, intact joining, no structural failure)
- Weak points to be further investigated: interlayer thickness (is 1 mm really necessary?), standards and codes for novel materials of pipes (WfCu), neutron damage on materials, possible scale-up of selected concepts, performances under long-pulse thermal loads

