

Practical model for AVDE loads calculation

<https://www.mdpi.com/2571-6182/7/1/12>

*Sergei Sadakov, Fabio Villone, Daniel Iglesias, Luis Maqueda,
Jesus Almenara-Rescalvo, Guglielmo Rubinacci,
Salvatore Ventre, Joris Paret*

*The 3-rd IAEA Technical Meeting on Plasma Disruptions and their Mitigation:
Held at ITER Organization - Saint Paul lez Durance - 03-06 September 2024*

1. Introduction

2. Main features of AVDE EM model

3. Results in terms of direct EM loads

4. Tokamak dynamic response to AVDE

5. Conclusions

1.1 The engineering sense of plasma disruption studies:

- The engineering sense is **to fill Load Specifications** for all tokamak parts: Particularly, indicate MD, VDE & AVDE-induced loads: heat, RE, EM loads.
- While talking on EM loads, Load Specifications shall indicate not one set of 6 vectors of time-dependent net EM forces & moments (3+3) for each structure, but **several variants of such loads with assigned numbers of load cycles**.
 - This is to quantify design margins, fatigue, failure modes, etc.
- Having in mind widely varying input conditions & scenarios, AVDE loads to be delivered in the **parametric manner, to fill a “library” of AVDE loads** for various scenarios of VDE to AVDE transition, severity, rotation, etc.).
 - ***The parametric calculations are very classical way to decouple the engineering process from the never ending physics simulations.***

1.2. This EM model for AVDE loads calculation was suggested and implemented in the Tokamak Systems Monitor (TSM) team: ITER IO, Create and Esteyco (simulated dynamic response):

- Because TSM team searched, but did not find a complete enough set of AVDE loads as input for the testing of relevant algorithms.
- TSM algorithms for reconstruction of tokamak response to AVDE-induced EM loads to be tested with a complete set of AVDE-loads (3+3=6 net vectors for the VV and 6 reactions for the Magnets).

While talking only on EM loads induced by MD, VDE, AVDE:

- I think all non-replaceable parts in tokamaks can and shall be designed **to surely withstand all anticipated MD- VDE- & AVDE- induced loads.**
- Thus, the basic engineering task is to adequately specify in all relevant Load Specifications (LS) amplitudes of net EM plus inertial forces and moments, exemplary waveforms and the assigned numbers of loading cycles for MD- VDE & AVDE events in a variety of considered variants.

1.3 What specifically we are doing and what we don't:

Here we are NOT simulating plasma evolution at VDE, neither transition in AVDE.

Instead, (1) we take, **as our inputs**, some ready VDE scenario and (2) introduce some degree of AVDE distortion and calculate EM loads on very detail EM model.

Yellow: A typical model for VDE loads; **Red & Green:** Paired helical bridges added to calculate AVDE loads.

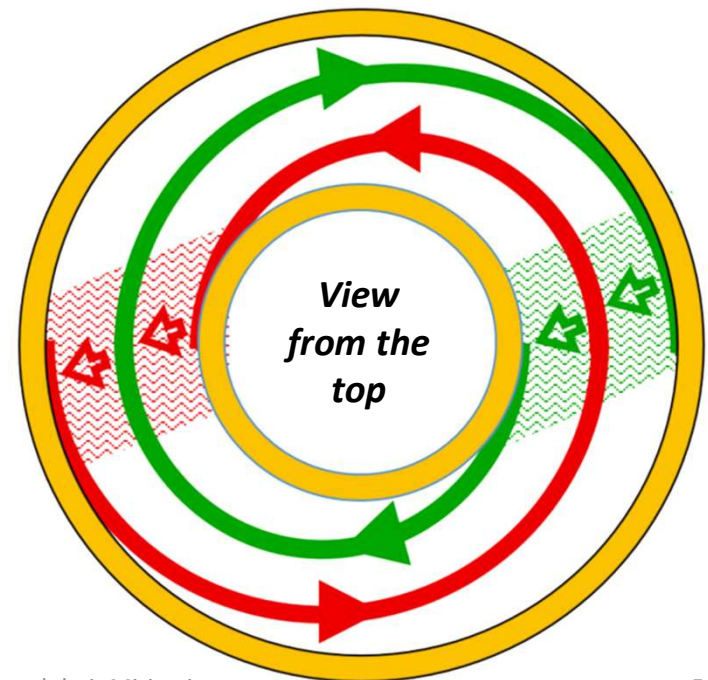
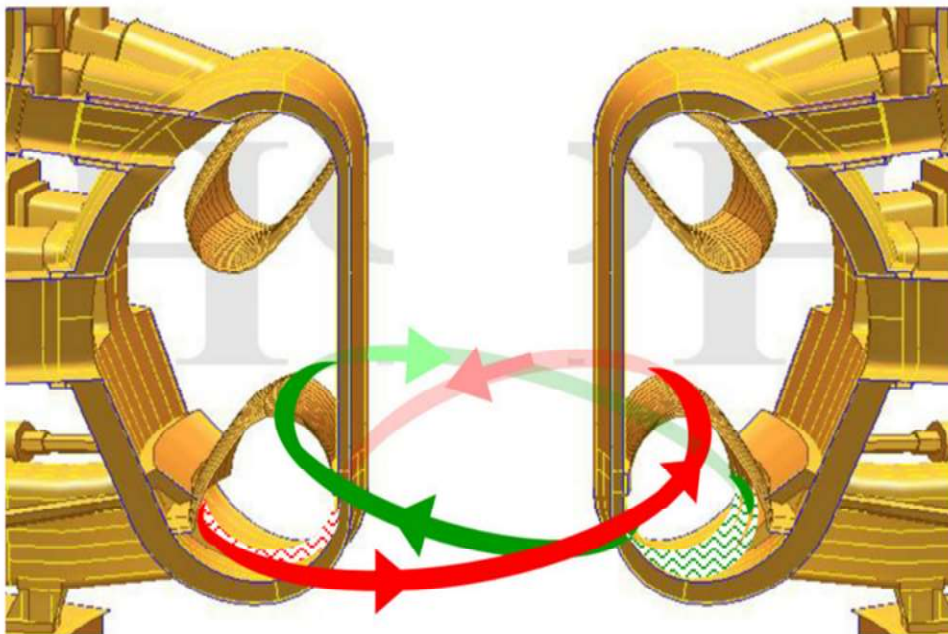

1.4 Calculation of EM loads at symmetric – or asymmetric events:

Typical procedure for calculation of EM loads at the symmetric events:

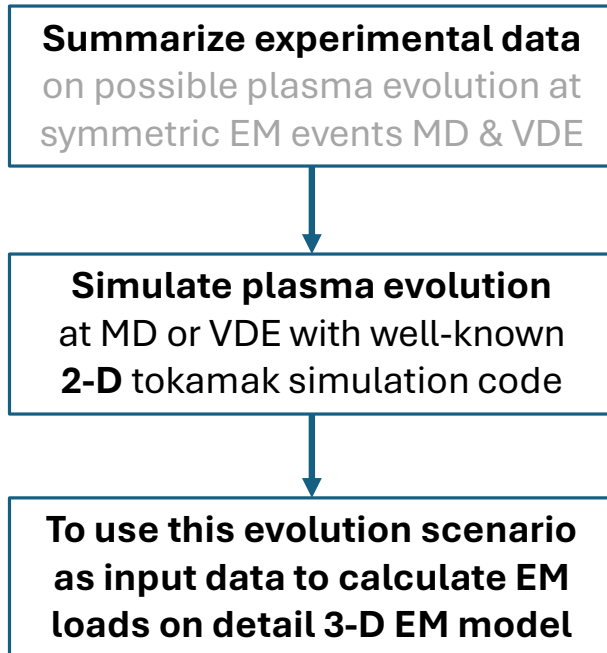

We calculate AVDE loads as marked by yellow:

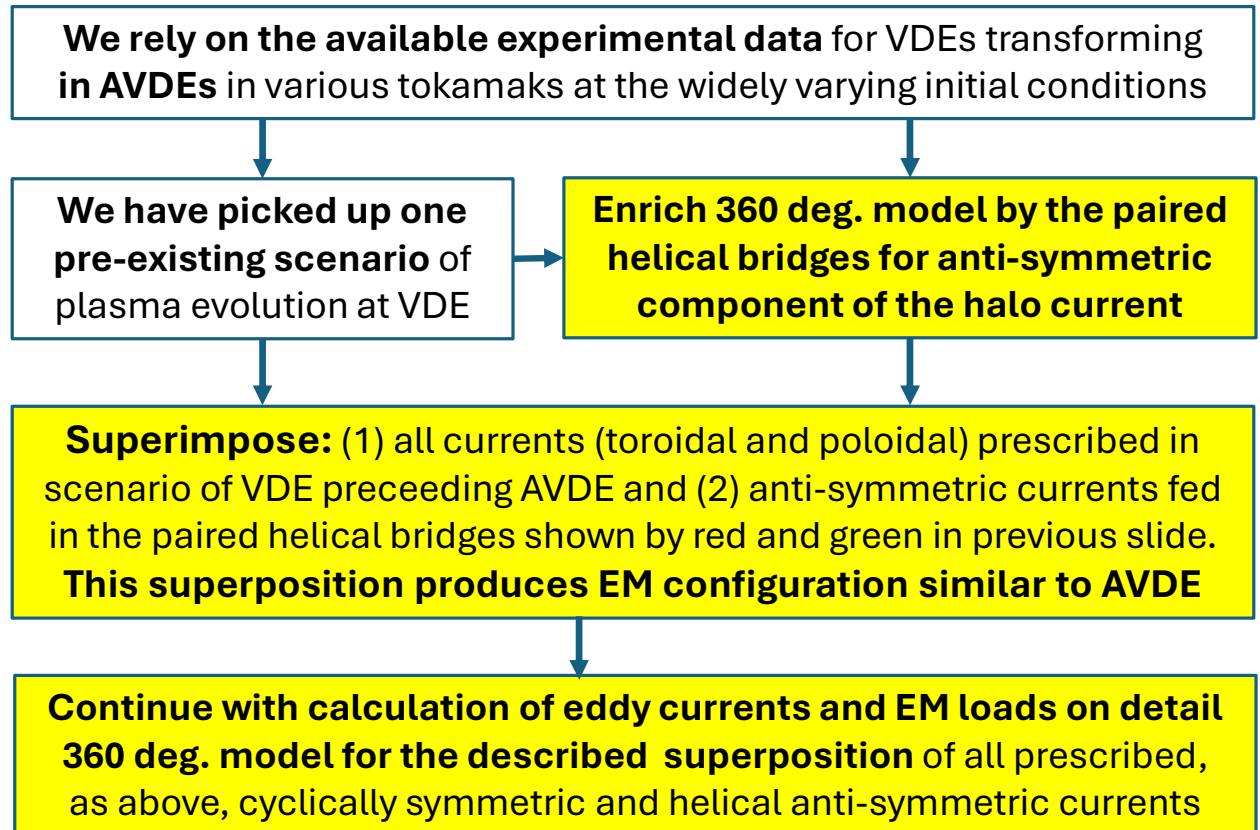

1.5 Superposition of all symmetric and anti-symmetric currents

Yellow parts show main conductive structures and poloidal bridges carrying poloidal component of the halo currents in a typical model for VDE postprocessing (40 deg. model, visualization by Efremov team).

Red and **green** helical bridges are added to carry anti-symmetric helical component of halo current to develop EM configuration resembling one which exists at AVDE (360 deg. model built by the Create team).

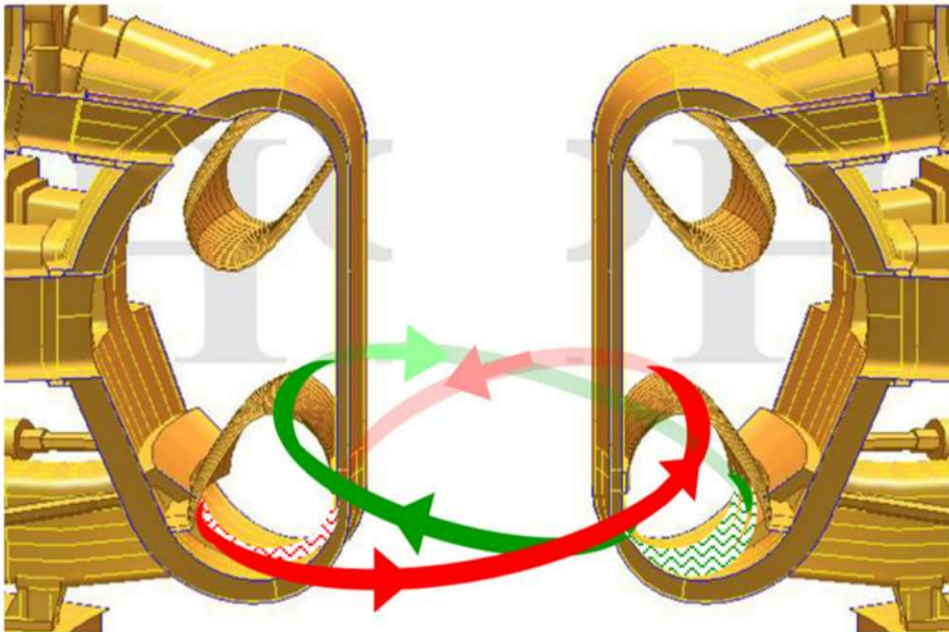

*Our FE model has 4 layers of helical bridges, with 100 filaments per layer: $4 * 100 = 400$*

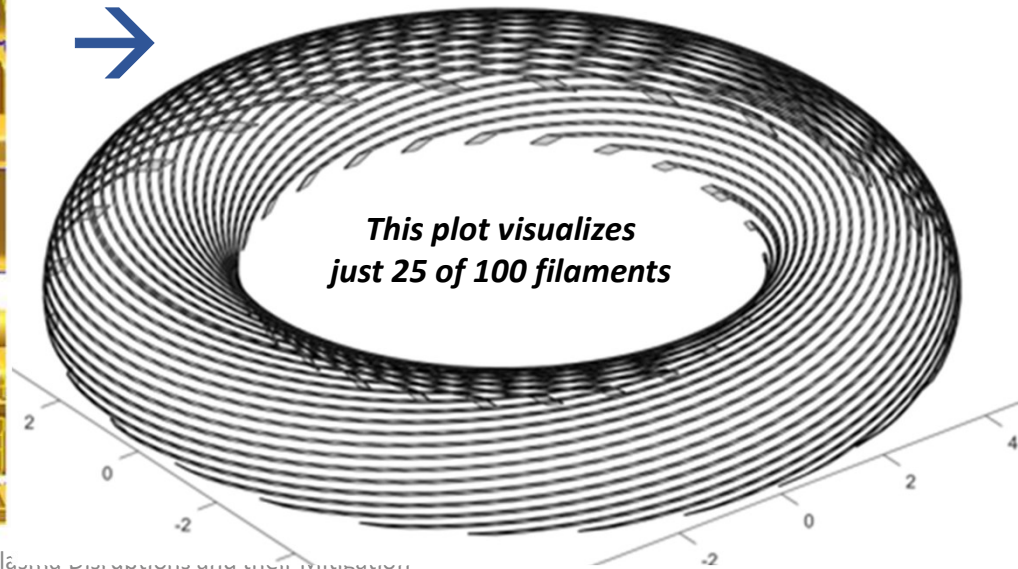

1.6 *Wide efforts are on interpretation & simulation of AVDE physics:*

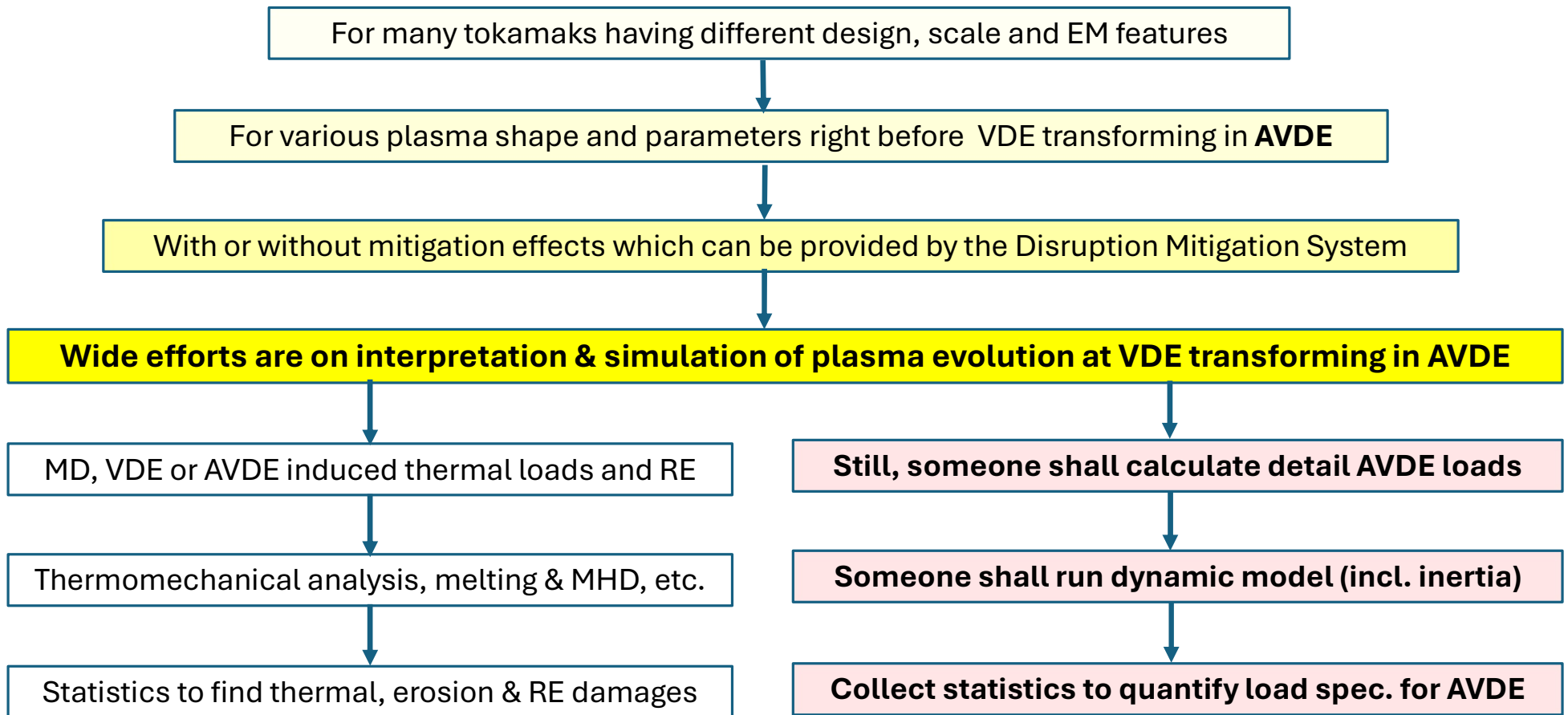

1.7 Widely varying inputs → Proceed in a manner of parametric study:

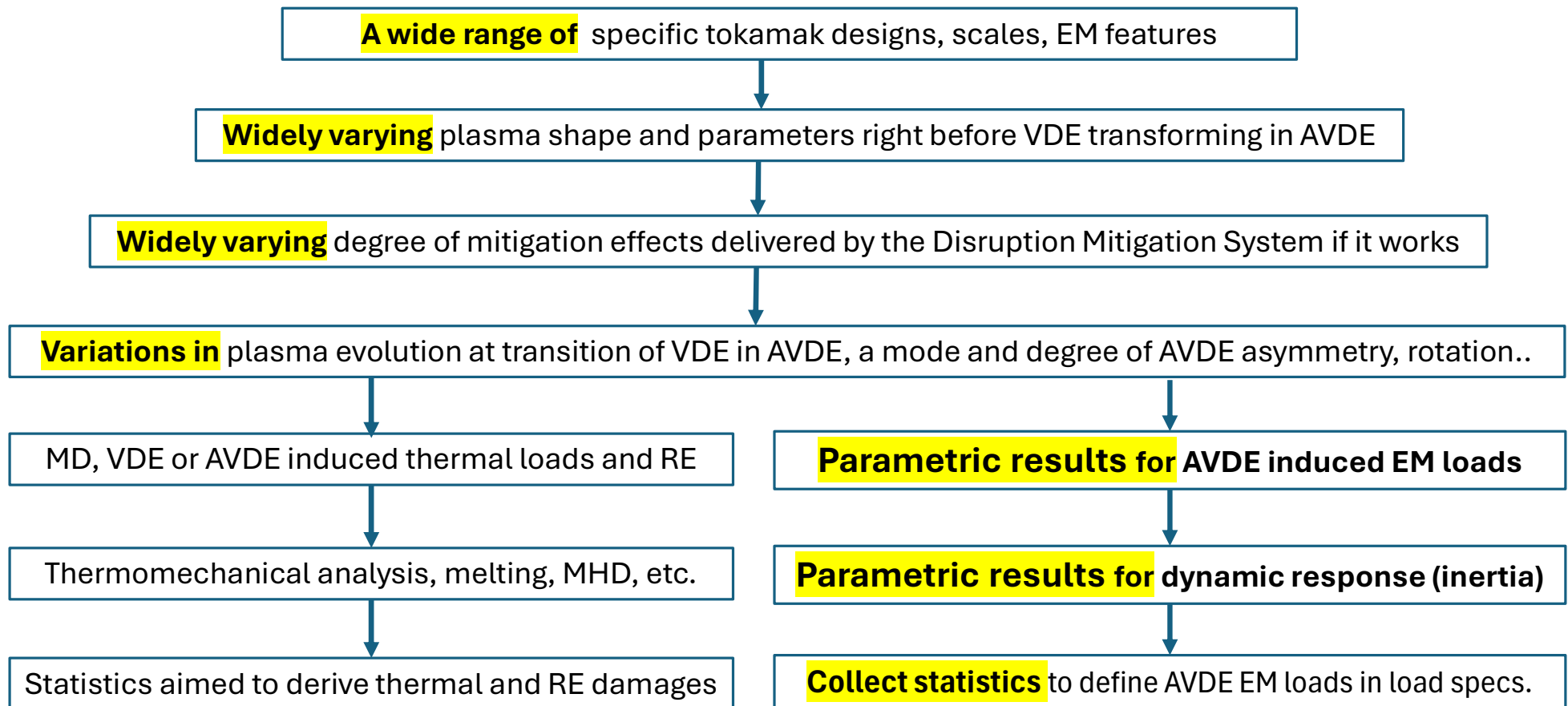

1.8 Specific inputs taken for the first practical run:

To contribute to the parametric studies, for each specific run we select:

- Specific tokamak design & EM features:
→ We show AVDE loads **for ITER baseline**.
- Specific VDE evolution scenario:
→ We have picked **the slowest VDE downward**.
- The first model assumption on how the VDE transforms in the AVDE:
→ These results are for **AVDE with TPF=1.5 & 2.0, helicity ($m=1; n=1$), constant in time**.
→ However, the same model is ready to be run for AVDE distortion growing with time.
- The present model can be used for either the locked or the rotating AVDE:
→ **These results are for the locked AVDE**.
→ The same EM model can be used for the rotating AVDE.
- We are asking the **physics community to recommend inputs** for next parametric runs.

1. Introduction

2. Main features of AVDE EM model

<https://www.mdpi.com/2571-6182/7/1/12>

3. Results in terms of direct EM loads

4. Tokamak dynamic response to AVDE

5. Conclusions

2.1 Details on helical bridges for the anti-symmetric halo currents

- In each pair, **Red & Green** helical bridges have identical shapes, spaced toroidally by 180 degrees and fed by opposite (“mirrored”) prescribed current waveforms;
- The same can be said about currents in each pair of helical filaments in FE model;
- Being superimposed with all prescribed currents in the VDE post-processing model, followed by calculation of all eddy currents, etc., anti-symmetric halo currents these helical bridges **produce all 6 vectors of AVDE loads without duplication or omission**;

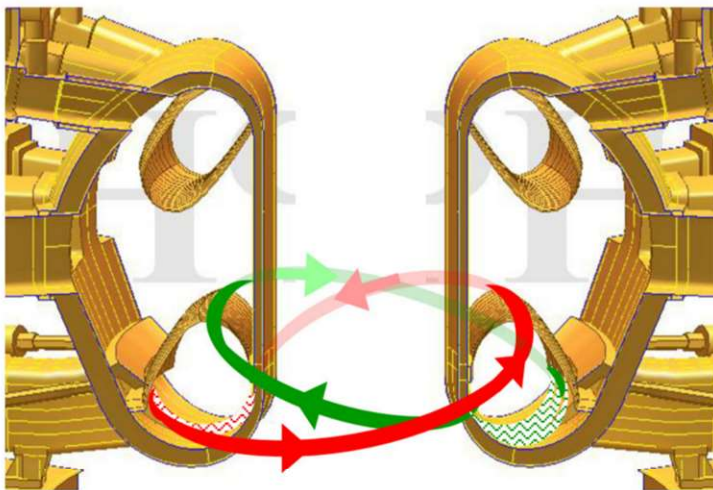

9/5/2024

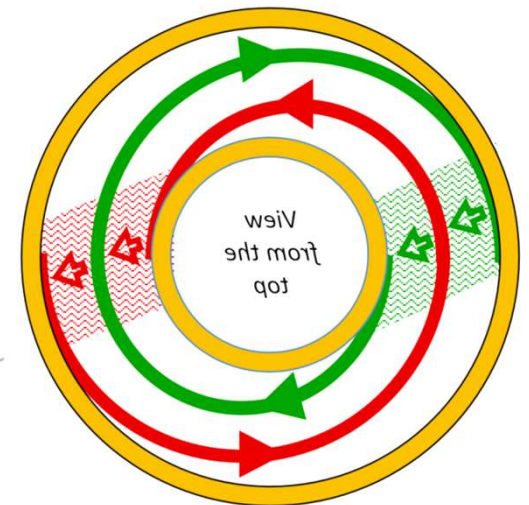
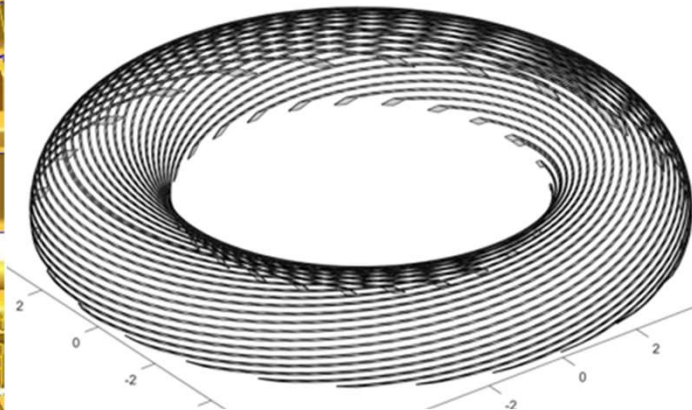

The 3-rd IAEA Technical Meeting on Plasma Disruptions and their Mitigation

2.2 Superposition of three time-dependent current patterns:

- (a) An **axi-symmetric toroidal current in the plasma core** that always stays axi-symmetric during plasma equilibrium evolution at VDE and AVDE;
(taken for a selected VDE from the ITER DINA library as usually done for VDE)
- (b) An **axi-symmetric poloidal current in the gradually compressing halo layer**;
(taken from the ITER DINA library for the same VDE, as usually done for VDE)
- (c) An **anti-symmetric helical pattern of the halo current component is added in FE model artificially, mimicking the most-known experimental results.**

The model does not simulate yet Shafranov's shift corresponding to AVDE distortion: Such simplification is acceptable for purposes of loads calculation because covered by a much wide uncertainty range of parametrically varying VDE & AVDE scenarios.

Current patterns (a) and (b) were used previously in the same way for VDE post-processing. **Pattern (c), newly built,** does upgrade the EM model to AVDE post-processing. Of course, the model is expanded from 40 deg. to 360 deg., what was not realistic several years ago.

2.3 *Intrinsically assured balances of EM loads & magnetic fluxes:*

Term “helix” is for each elementary current loop formed by one helical filament and closed via tokamak conductive structures. **In each pair of helixes spaced mutually by 180 degrees:**

- **One helix creates 3 net forces and 3 net torques** on the VV and the Magnets by interacting with eddy currents in the VV and with all currents flowing in the windings of the Magnets.
- **Its “antipode” also creates 3 net forces & 3 net torques** on VV and the Magnets, with the same 6 moduli: **some co-directional with, but others opposite to**, the loads created by the first helix.
- **These 2 helixes do contribute in the lateral AVDE loads without duplication or omission.**
- **Superposition of currents in all pairs of helixes with all currents used in VDE postprocessing gives all 6 vectors of 3D AVDE loads (3 forces & 3 moments) without duplication or omission.**
- In respect of magnetic fluxes in toroidal & poloidal fields, the paired helixes have opposite flux linkages, thus, **do not disturb plasma flux balance as it was simulated for still symmetric VDE.**

Superposition of time dependent currents prescribed to all filaments in plasma volume (toroidal, poloidal and helical), the halo and eddy currents in the conductive structures, and currents in all coil’s windings (in the freewheeling mode) allows for calculating of maps of the pulsed EM force densities and concludes with waveforms for 6 net load vectors for the VV and the Magnets. Also, it preserve plasma flux linkages which were delivered by simulation of VDE evolution.

2.4 Superposition in terms of **vertical and lateral load vectors**:

Basically, the above means that:

- **Toroidally symmetric current components** (toroidal & poloidal at still symmetric VDE) **contribute only to vertical** net forces and moments at VV and the Magnets:
 - *They contribute just 2 out of 6 net load vectors at either VV or the Magnets:*
 F_z and M_z ,
- **Whereas anti-symmetric halo component** (in the paired helical bridges, closing via structures) **causes exclusively the lateral** net loads at the VV and the Magnets:
 - *This component causes the remaining 2+2= 4 net load vectors:*
 F_x, F_y, M_x, M_y (in the global Cartesian coordinates).
 - *This is proven by numerical results shown in next sections.*

2.4 Cont. Superposition in terms of *vertical & lateral net EM load vectors*:

Regarding the **vertical** vectors of net loads: Each helix creates some vertical net forces and moments acting on the VV and the Magnets. Its “antipode”, having the same shape but opposite current, creates exactly opposite vertical net forces and moments acting on the VV and the Magnets. Thus, **each pair of helixes creates zero net vertical force and moment acting on the VV and Magnets**, and therefore does not disturb the vertical load balance as it was delivered by the preceding VDE plasma evolution simulation code and preserved then at the consequent VDE post-processing.

Regarding the **lateral** vectors of net loads: Because of the 180-degree toroidal spacing in each pair of the helixes, combined with perfectly “mirrored” currents, **vectors of lateral forces acting on either VV or Magnets are not compensating but summing**. Similarly for the lateral moments: The 180-degree spacing, being combined with mirrored currents, causes pairs of opposite vertical EM forces acting on the VV and the Magnets along well-spaced parallel vertical lines. These pairs of opposite vertical forces create serious lateral **“overturning” moments** which may be seen as dominant components of AVDE loads.

2.5 Typical Q&A at previous presentations on this AVDE EM model:

- Tokamak Systems Monitor (“TSM”) team has developed this model because **we did not find a suitable, complete enough set of AVDE loads needed as input for the testing of TSM algorithms.** TSM algorithms to be tested on a complete set of AVDE-induced EM loads (6 net vectors for VV and 6 reactions for the Magnets).
- Simplistically, the model can be seen as an **upgrade of well-known models for VDE** post-processing (e.g. on TYPHOON or CARIDDI codes). It preserves main features of these VDE-postprocessing models. For AVDE it is expanded from 40 to 360 deg.
- This specific model was built and run with the **CARRIDDI code by the Create Team**, similarly as the Create Team did it for a long time for MD and VDE postprocessing.
- This is **NOT a “sink-and source” model:** It fully obeys the law of the continuity of electrical currents, including loops of halo currents. Also, it mimics EM effects of **gradual compression of halo layer**, similarly as the preceding MD & VDE models.

2.5 Cont.: Typical Q&A at previous presentations on this model:

- Unlike earlier AVDE models, **it intrinsically assures the balance of net EM loads** in a tokamak as the closed EM system. It delivers not only 6 net EM load vectors (3 forces & 3 moments) at VV with internals, but also all 6 exactly opposite load vectors at the Magnets, with zero total for tokamak for each of 6 load vectors.
- This EM model for calculations of AVDE loads **intrinsically preserves the poloidal and toroidal magnetic flux balances** delivered in simulation of the preceding VDE.
- All coils are considered in **the freewheeling mode**, as it is usually done with the CARIDDI and with many others EM postprocessing codes (including TYPHOON).
- This specific model mimics AVDE with $TPF=1.5$ & 2.0 ($m=1; n=1$) evolving from the preceding VDE, specifically from the “VDE DW Slow Revised” taken from ITER DINA library. Being selected for the purposes of TSM studies, these VDE & AVDE scenarios are perhaps not the worst AVDE in terms of lateral EM loads: In any case **the task is to outline possible range of AVDE loads via multiple parametric runs.**

2.6 AVDE EM loads have been calculated on 360 degree tokamak EM model run with CARIDDI code (FE model is illustrated by parts over next 4 slides)

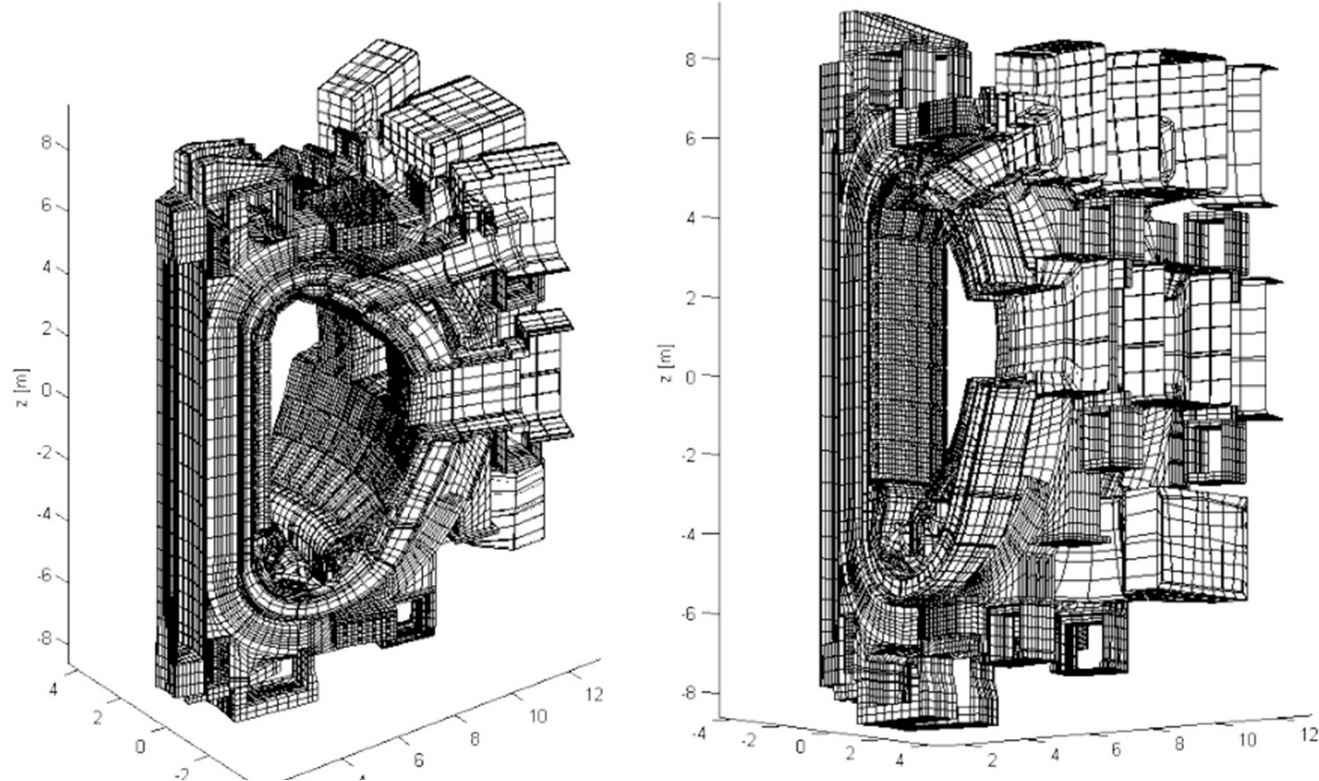

FE mesh of a 40-deg. sector of the VV with ports, blanket and divertor, and cold structures of CS, PF and TF coils. All coil windings are hidden for a better visualization. This mesh was a part of **40-deg.** model used for VDE post-processing and has since been expanded, with modest simplifications, to **360-deg.** mesh as needed for calculation of AVDE-induced EM loads.

2.7 FE meshes for the CS, PFC and TFC windings (shown for 40 deg. sectors, but modelled for 360 deg.)

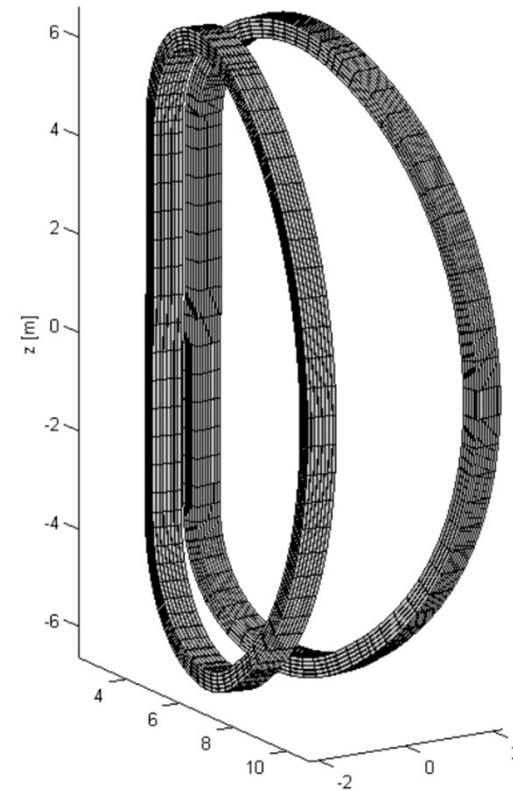
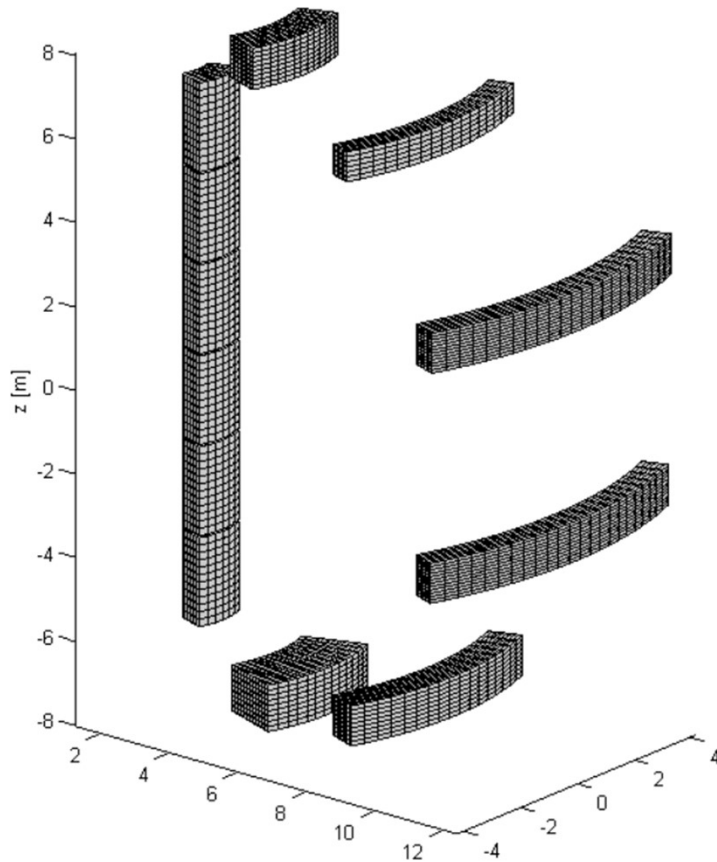

**2.8 360 degrees FE model of the VV and divertor:
exterior and interior views**

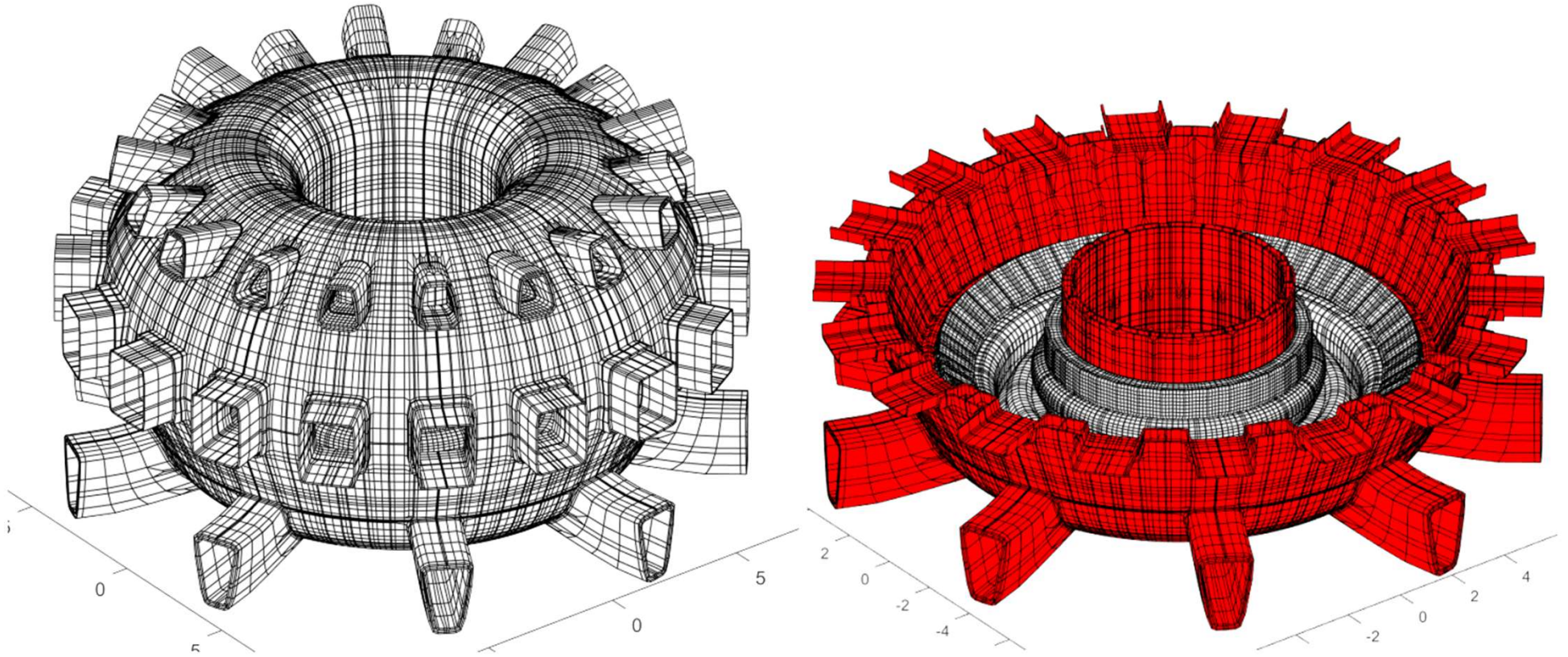

2.9 Zoom-in to the VV interior, divertor panels, 1-st & last blanket rows

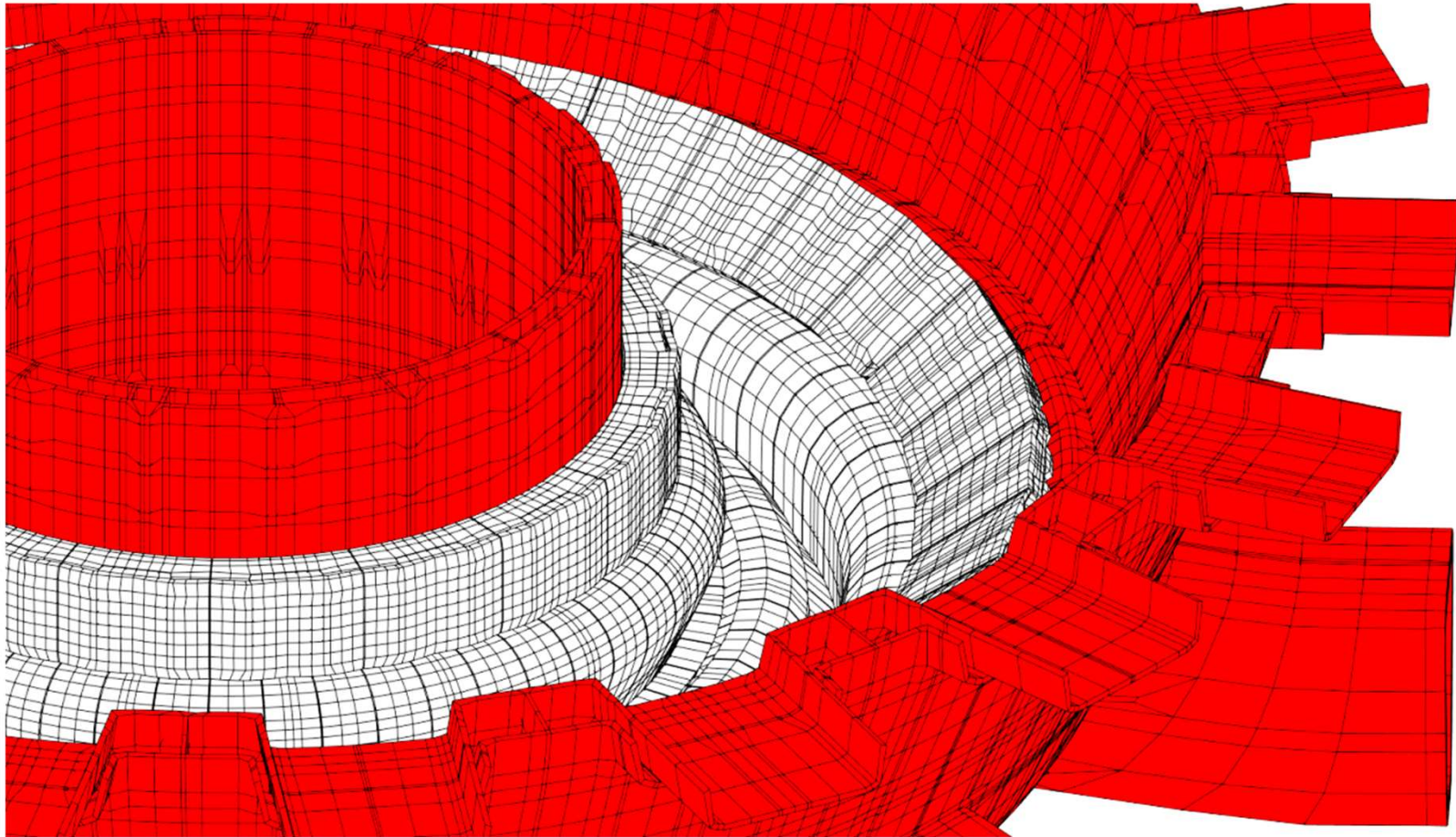

2.10 Scenario of the preceding VDE DW Slow Revised from ITER DINA library

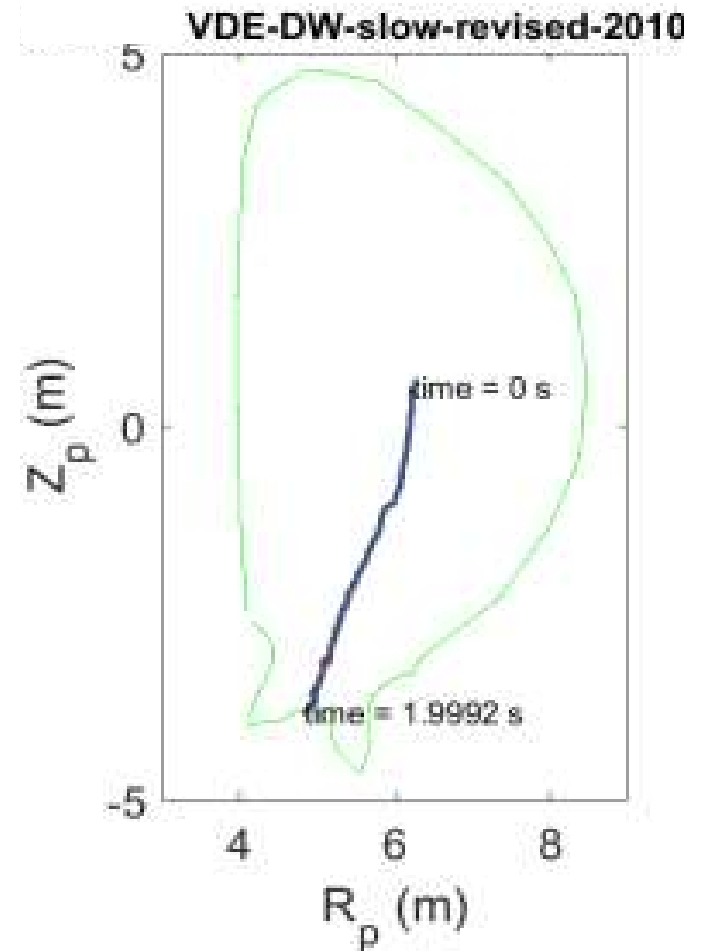
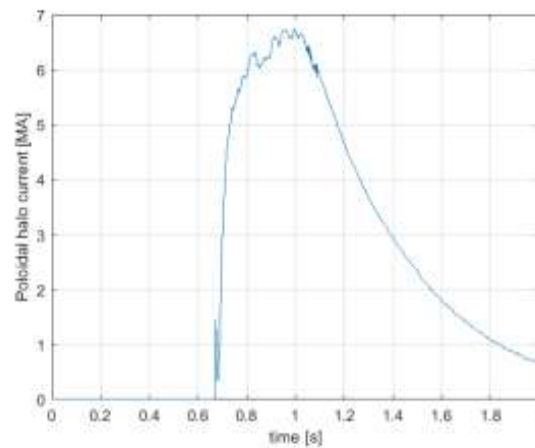
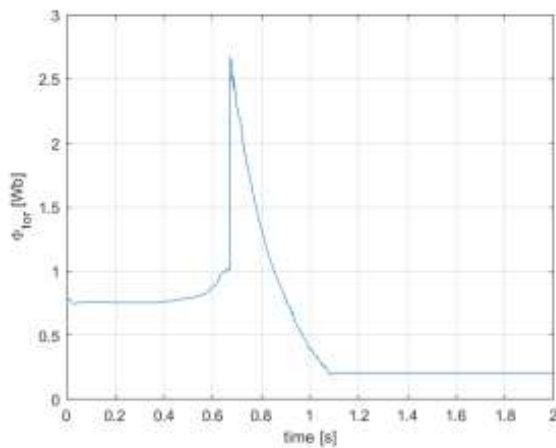
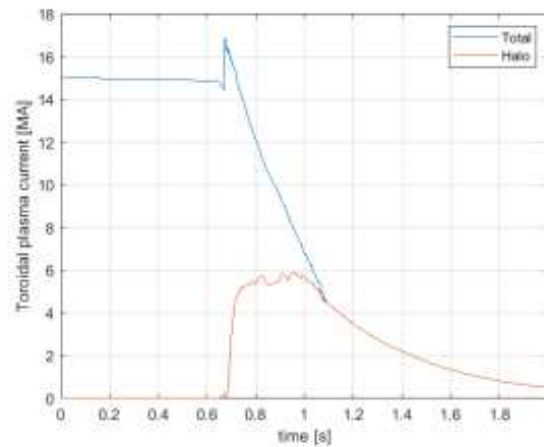
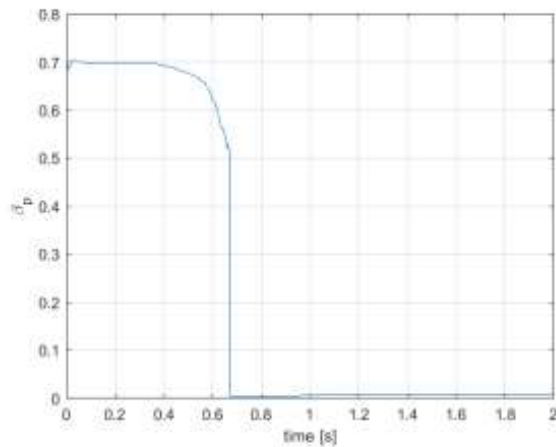

2.11 Plasma evolution in the preceding VDE DW Slow taken from the ITER DINA library

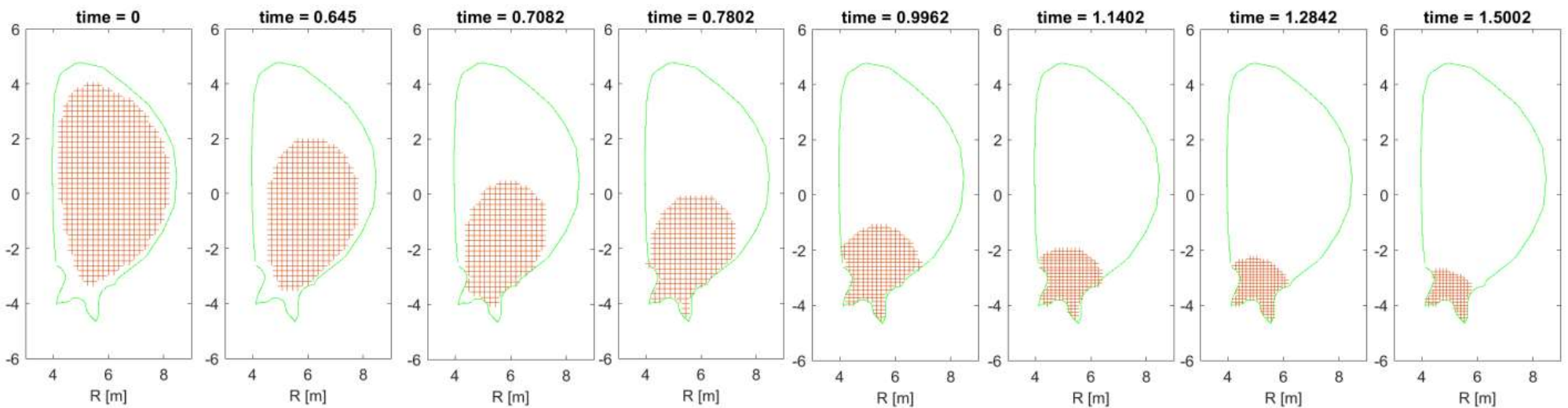

2.12 Evolution of the halo layer profile (blue line) in the preceding (symmetric) VDE scenario delivered by DINA code

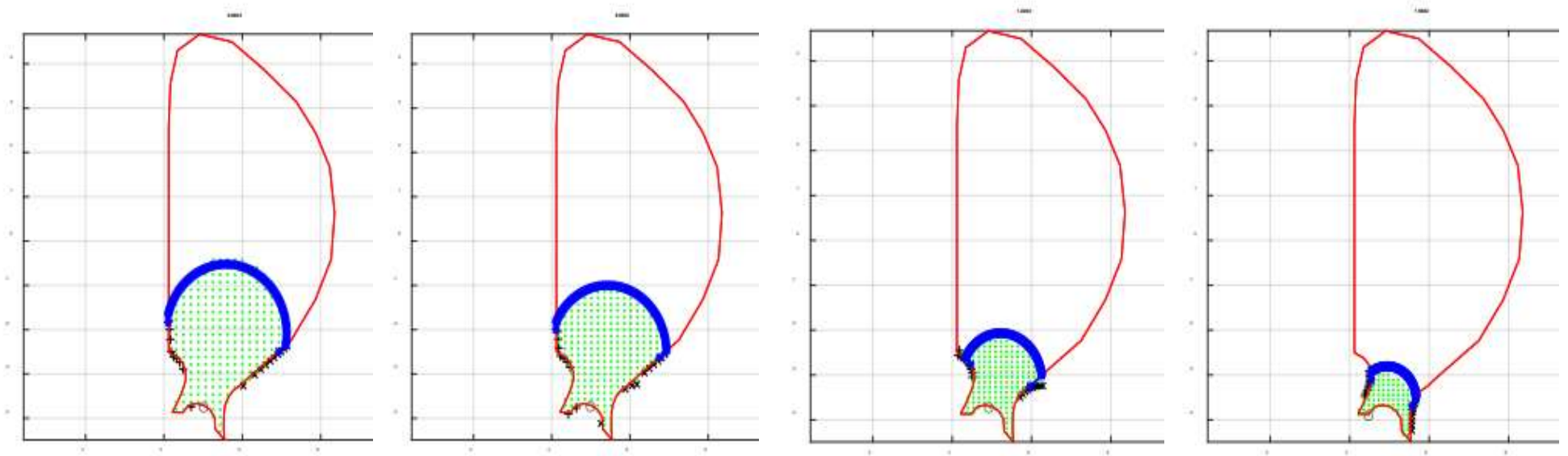

2.13 Configuration of poloidal bridges built in the FE model still for VDE post-processing and allocation of halo-to-wall interception belts corresponding to these four halo bridges

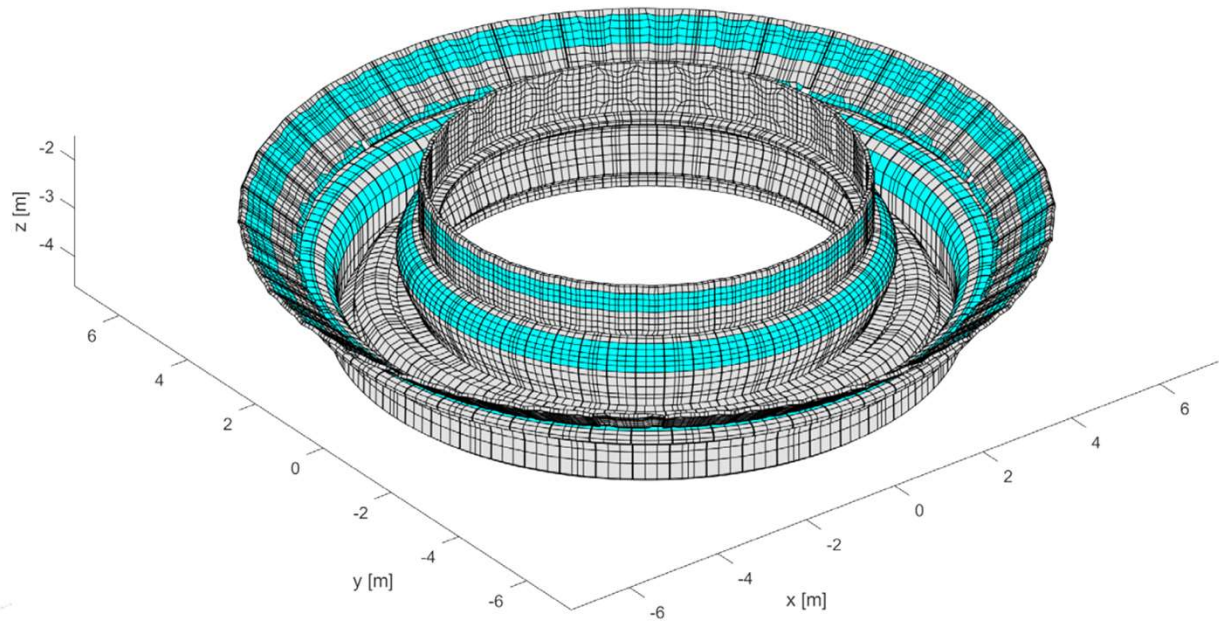
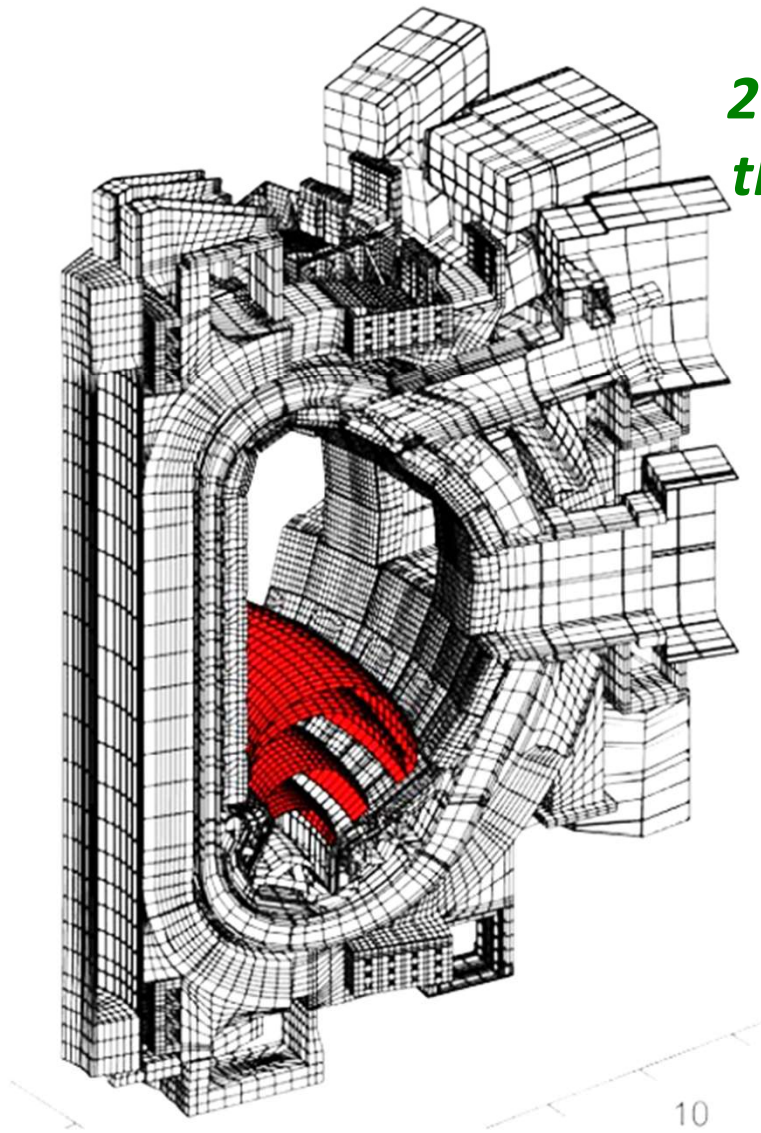

2.14 Helical filaments forming the first and last layers of helical bridges built for anti-symmetric component of halo current, and graphs of in-time modulation of the currents fed in four layers of the bridges.

For a better visualization these plots show not 100 but 25 filaments per layer

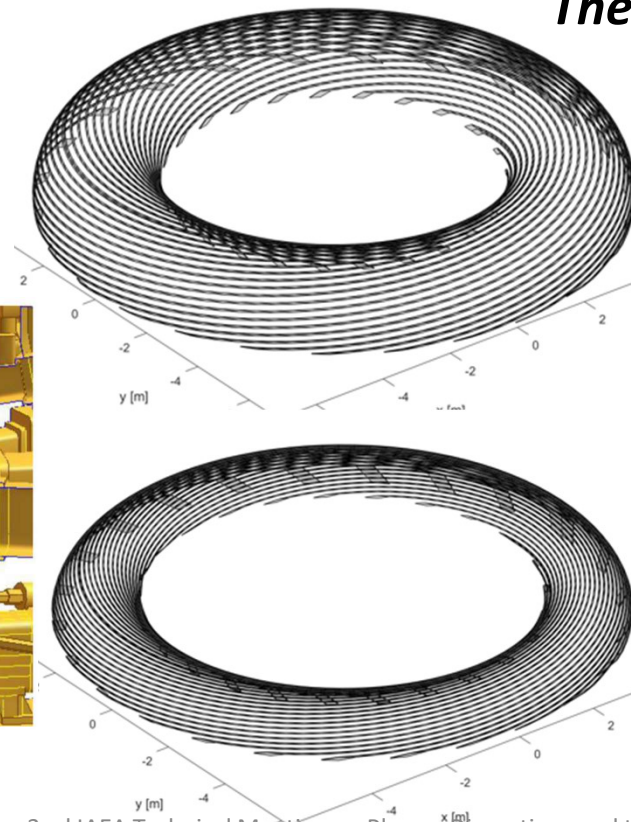
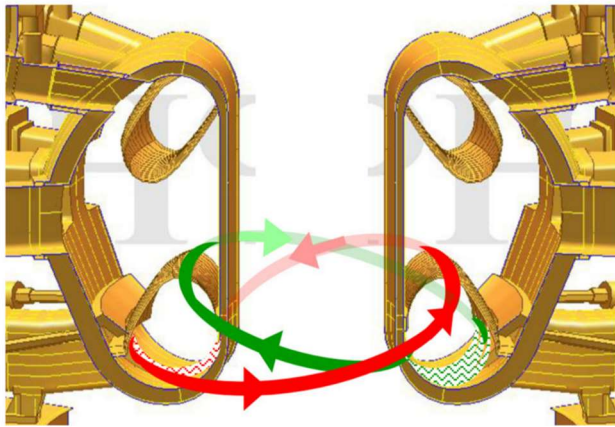

The in-time modulation is identical for poloidal & helical bridges.

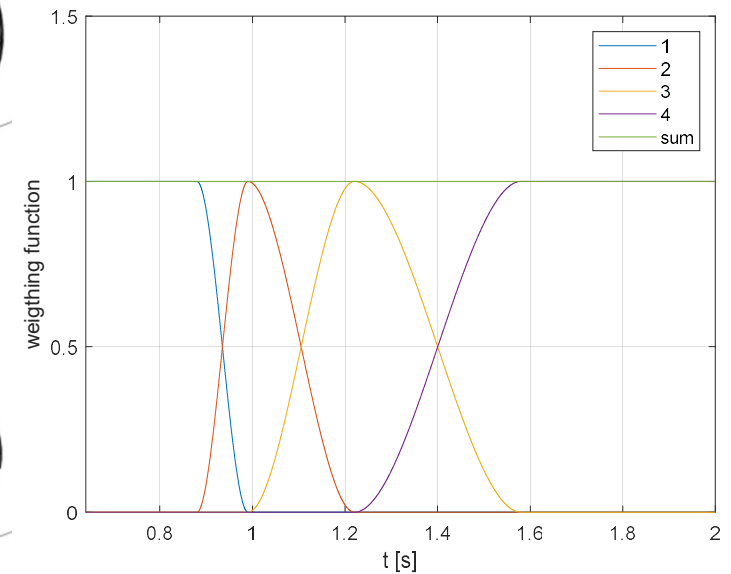

2.15 The balancing of net EM vertical forces still at the preceding VDE:

Waveforms of net vertical EM forces at the VV and the Magnets (the last is flipped over for a visual comparison) for the preceding VDE before and after the performed here net load balancing procedure. The initial imbalance accumulates due to **(1)** inexact imposition of vertical equilibrium constraint on the plasma at the simulation of plasma VDE evolution with significant halo current, **(2)** imperfect match of plasma evolution simulated on 2-D model of conductive structures with one on complex 3-D EM model.

The article explains a final AVDE load balancing technique used to obey the basic conservation law. Such procedure takes care on two stated above reasons and compensates invadable accumulation of error at the summation of numerous opposite elementary EM force vectors, almost compensating each other.

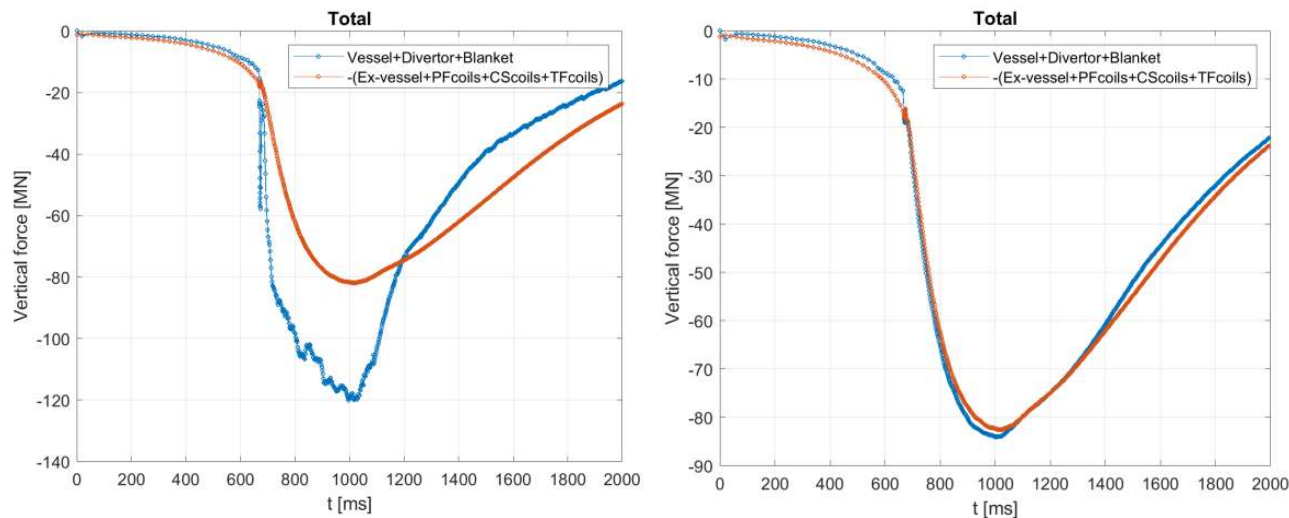

1. Introduction

2. Main features of AVDE EM model

***3. Results in terms of direct EM loads
at the VV and the Magnets***

4. Tokamak dynamic response to AVDE

5. Conclusions

The warning on the limited use of these specific results:

These AVDE loads should not be used directly for load specification, since they are obtained for arbitrary picked scenarios of VDE and AVDE distortion, not the worst in terms of peak EM loads, and without statistics.

Specific selection of VDE and AVDE evolution scenarios as inputs for calculation of AVDE loads for purposes of load specification, in terms of AVDE form and severity, shall be either suggested by- or agreed with the ITER physics team, and performed in the parametric manner, to outline the likely range of AVDE loads along each vector.

All plots are for “VDE Down Slow revised” distorted to $TPF=1.5$, ($m=1$; $n=1$):

Note: All plots show slightly elevated net lateral loads because they were calculated by a plain summing of magnitudes of elementary contributors found on FE mesh in the global Cylindrical coordinate system without accurate translation to the global Cartesian coordinate system. The table however shows exact results.

3.1 Net EM forces acting at VV, TFC, PFC, CS and total for the tokamak:

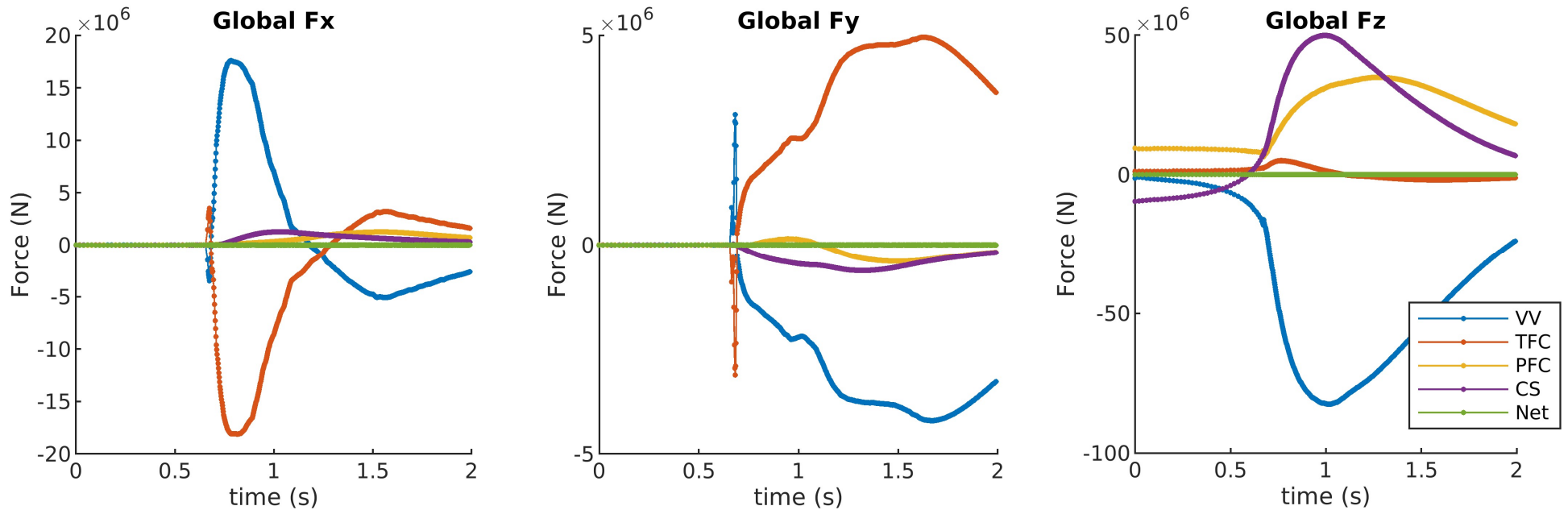

3.2 AVDE creates rather high lateral EM moments, M_x and M_y :

Net EM moments acting at VV, TFC, PFC, CS and total for the tokamak
(calculated at the origin located in the horizontal midplane of TF coils system)

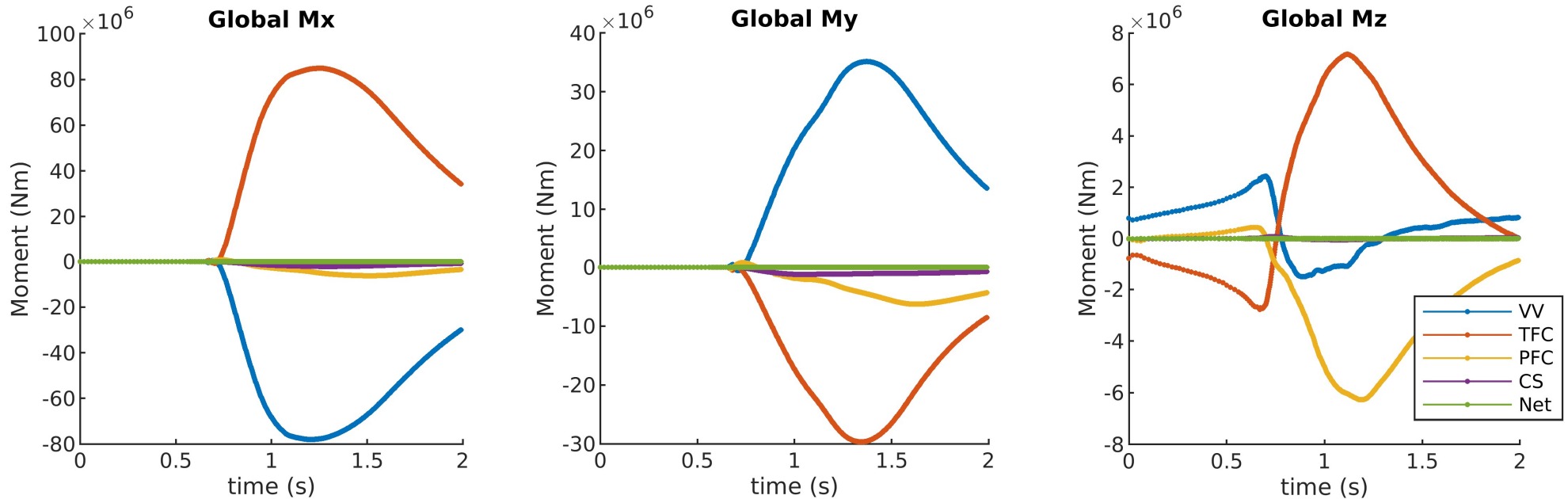

3.3 Extremes of net EM load vectors for the VV and the Magnets

Vertical net load vectors F_z and M_z are the same between VDE and AVDE, however, large **lateral** load vectors (F_x , F_y , M_x , M_y) do appear only at AVDE

Peaks of orthogonal vector components of AVDE induced EM loads calculated at $TPF=1.5$ (and scaled to $TPF=2.0$)

Loads calculated at assumption on $TPF=1.5$ and then scaled to $TPF=2.0$:	Vector	Peak net EM loads at the VV (balanced)	Ratio of lateral to vertical peak load vector
Peak net forces in EM interaction of the VV with internal components and the Magnets (the coils winding and cold structures)	Lateral F_x	+ 17 (+ 34) MN	0.20 (0.40)
	Lateral F_y	- 4.1 (- 8.2) MN	0.05 (0.10)
	Vertical F_z	- 85 (- 85) MN	1.0 (1.0)
Peak net EM moments between the VV and the Magnets, calculated for the tokamak's origin located in horizontal mid-plane of TF coils	Lateral M_x	- 78 (- 156) MN*m	35.5 (71)
	Lateral M_y	+ 30 (+ 60) MN*m	13.6 (27.2)
	Vertical M_z	+ 2.2 (+ 2.2) MN*m	1.0 (1.0)
Peak net EM moments between the VV and the Magnets, calculated for the alternative origin shifted down to level of tokamak supports)	Lateral M_x	-59 (- 118) MN*m	26.8 (53.6)
	Lateral M_y	+ 135 (+ 270) MN*m	61.3 (122.6)
	Vertical M_z	+ 2.2 (+ 2.2) MN*m	1.0 (1.0)

3.4 Sub-division of AVDE-induced net EM forces (F_r , F_t , F_z) between nine 40 deg. sectors composed by **VV shells**, **blanket modules**, **divertor panels** and total for all these

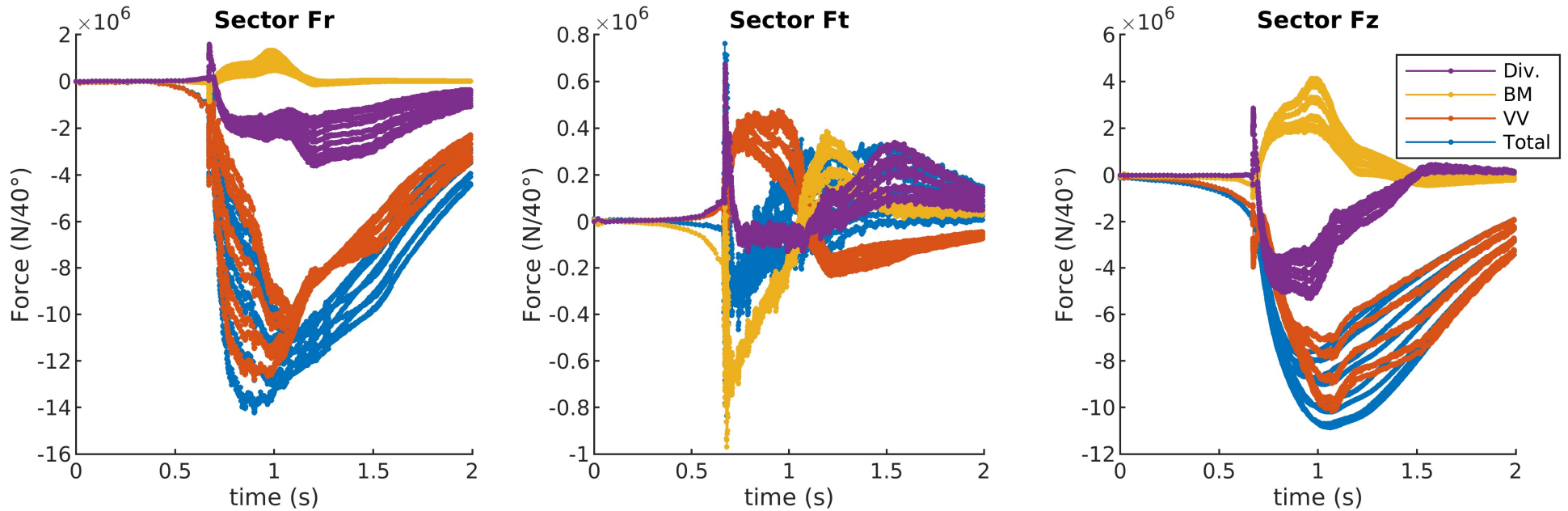

3.5 Toroidal distribution of 3 vector components (radial, toroidal, vertical) of net EM forces between nine 40 degrees VV sectors with relevant internal components at time instant $t=1196.2\text{ms}$

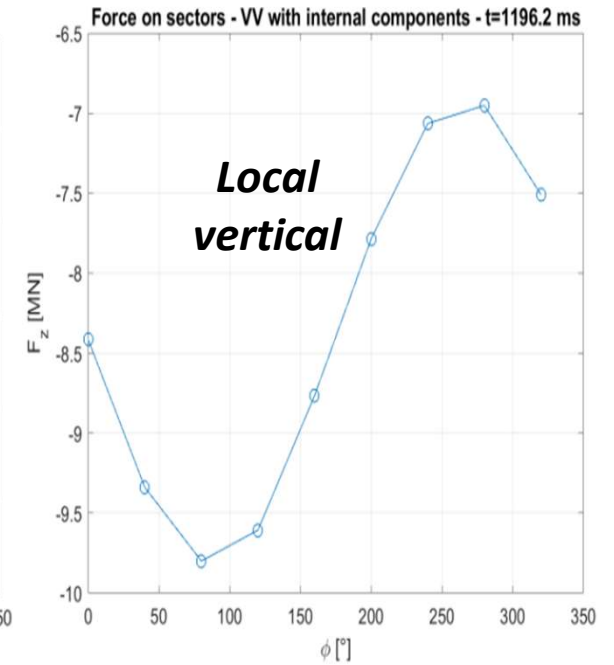
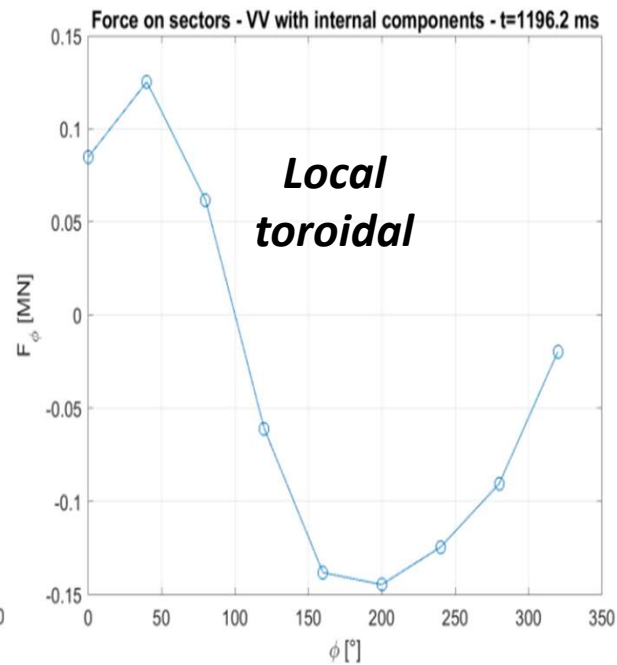
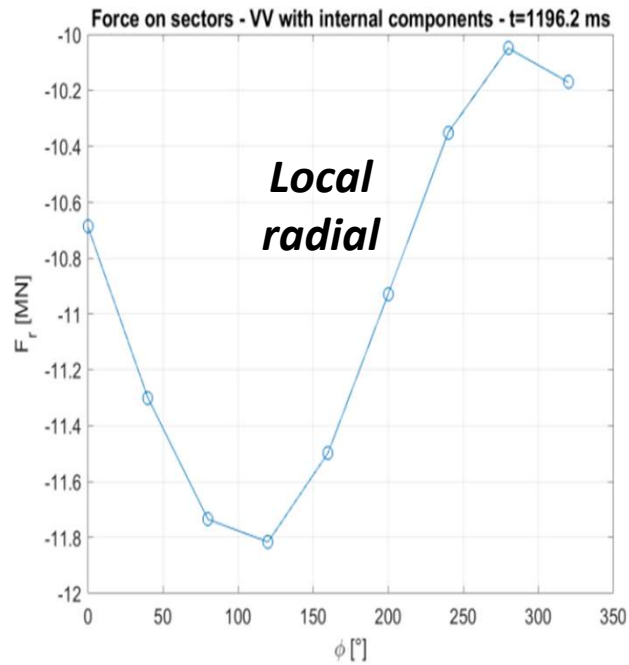

3.6 Sub-division of AVDE-induced net EM forces (F_r , F_t , F_z) between nine 40 degrees sectors of CS, PFC, TFC and VV

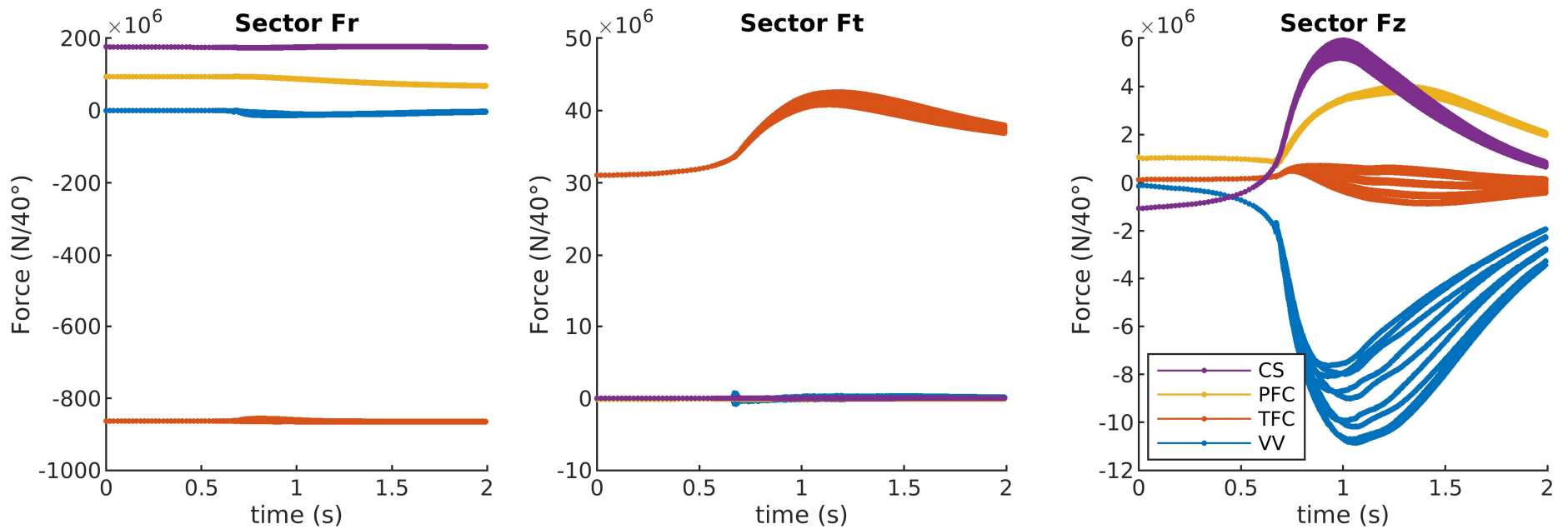

3.7 Sub-division of AVDE-induced net EM forces (F_r , F_t , F_z) between nine 40 deg. sectors of TFC cold structures, TFC windings and total for these

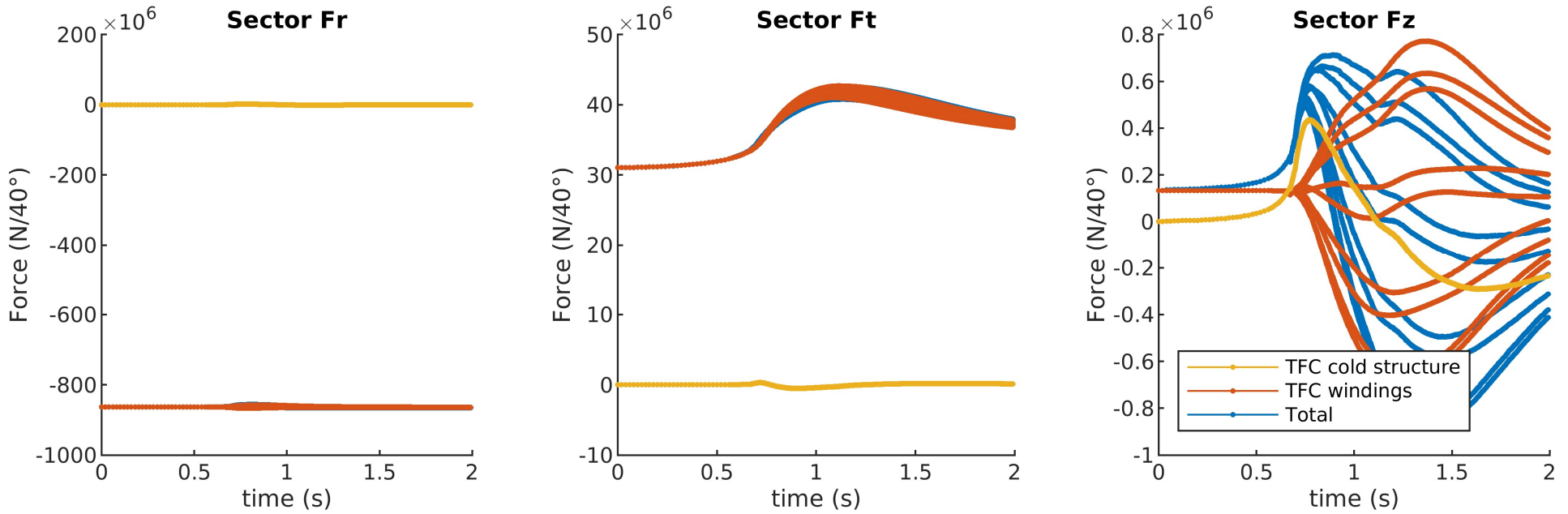

3.8 Sub-division of AVDE-induced net EM forces (F_r , F_t , F_z) between nine 40 deg. sectors of PFC cold structures, PFC windings and total for these

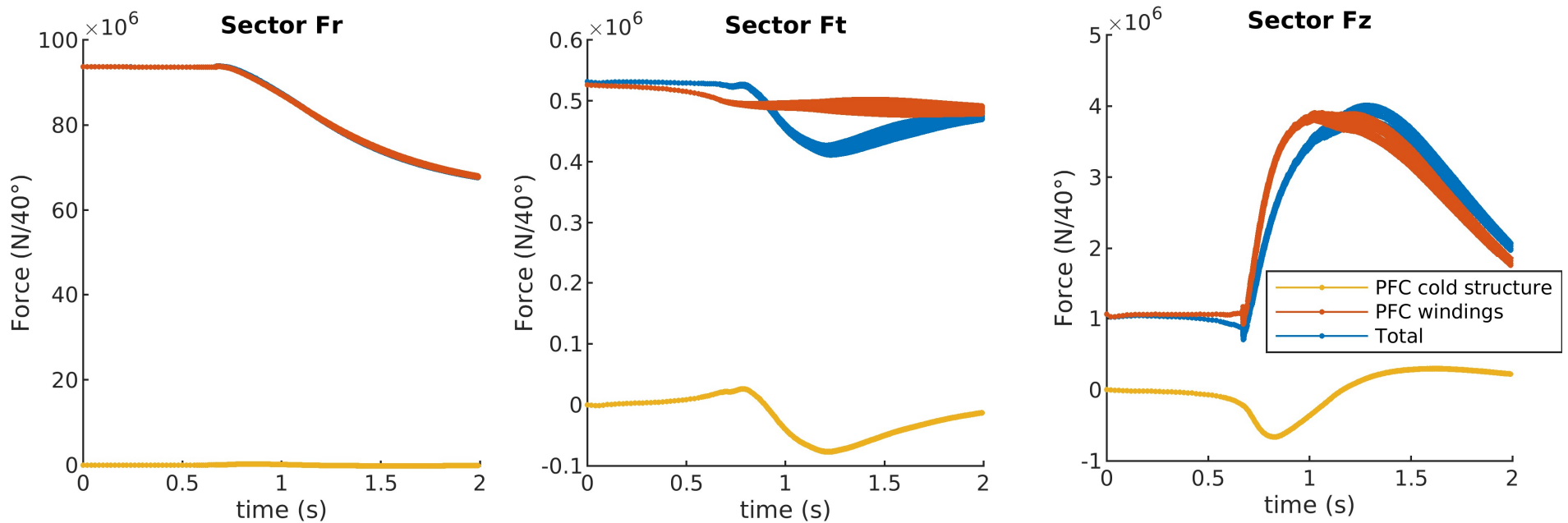

3.9 Sub-division of AVDE-induced net EM forces (F_r , F_t , F_z) between nine 40 deg. sectors of CS cold structures, CS windings and total for these

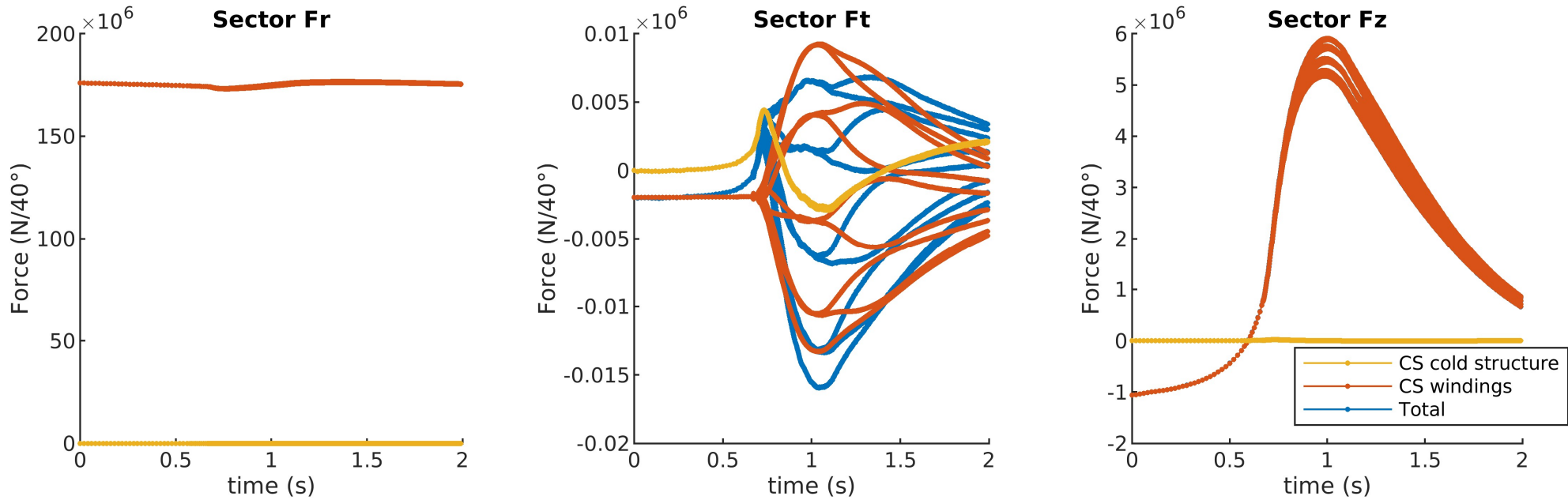

1. Introduction

2. Main features of AVDE EM model

3. Results in terms of direct EM loads

4. Tokamak dynamic response to AVDE

5. Conclusions

4.1 A scope of AVDE dynamic analysis

- The presented above direct EM loads have been applied to the tokamak dynamic model:
- Dynamic simulation results extracted from the 55.GT Framework TO.3 Interim Report: [Implementation of dynamic reconstruction algorithms for the 360-deg Tokamak Machine under A-VDE events \(9GSSWP\)](#)
- The AVDE-dynamics study focuses on the feasibility of the monitoring the machine's behavior under AVDE, as well as calculating the real forces acting at the main tokamak components and their structural interfaces

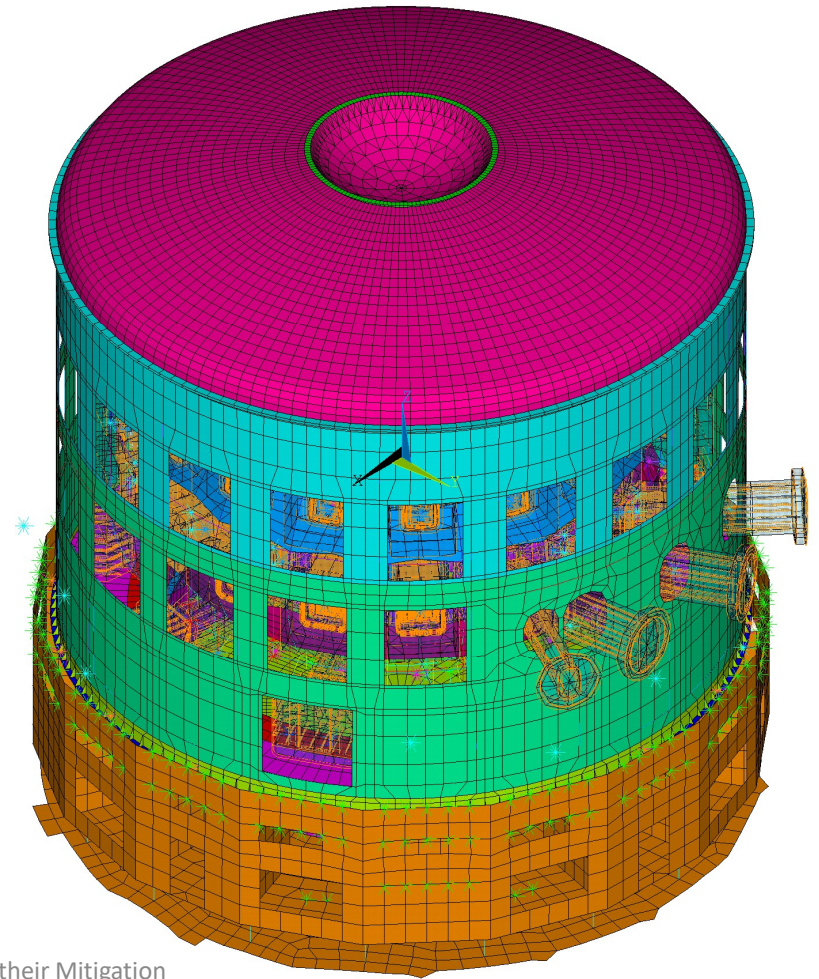

4.2 Loading of tokamak dynamic model by AVDE EM loads

- Complete **ANSYS load assembly model of ITER tokamak** has been used, with the added virtual sensors gathering “synthetic measurements”
- AVDE-induced EM loads are transferred from EM model to Dynamic tokamak model with the cross-checking that **3-D net forces do remain equivalent**
- Full transient analysis solved at **2.5 kHz** for capturing all major vibration effects
- We took the scenario of **the slowest VDE and accordingly the slowest AVDE**, which cause accordingly the weakest dynamic response of the entire tokamak. The purpose was to develop and test TSM algorithms for not for the easiest but the hardest conditions: for relatively weak dynamics (low accelerations).

4.3 Comparison of VDE and AVDE net EM forces in the interaction between VV and the Magnets, in MN

VDE

3×10^{-6}

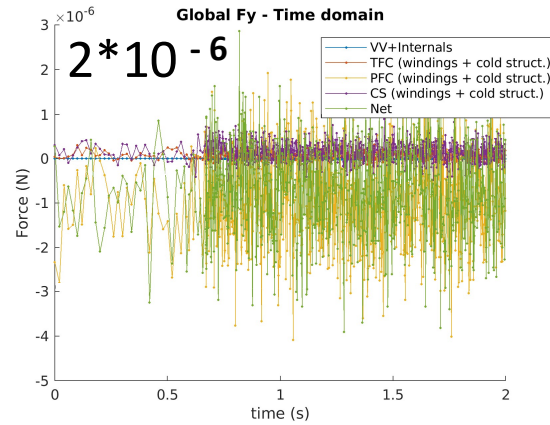
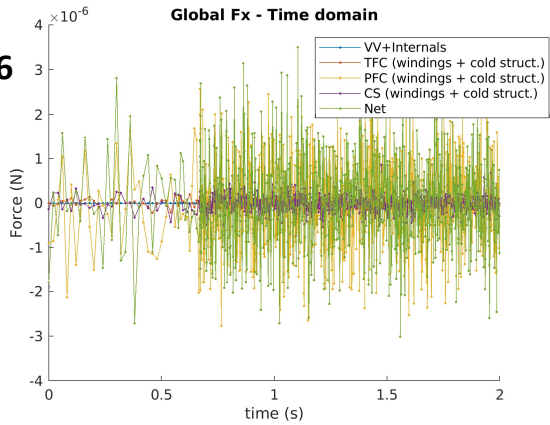

2×10^{-6}

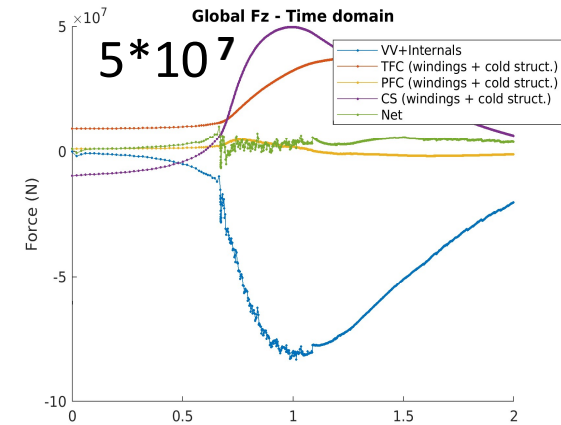

5×10^7

AVDE

20×10^6

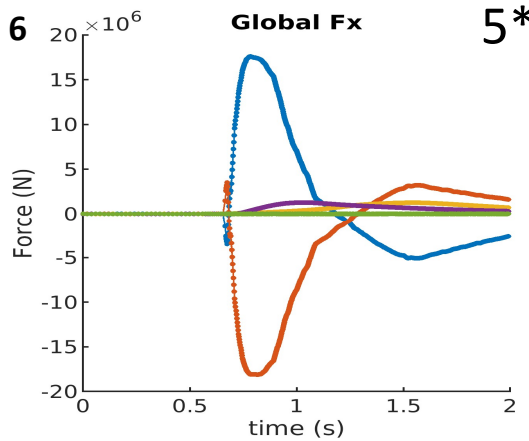

5×10^6

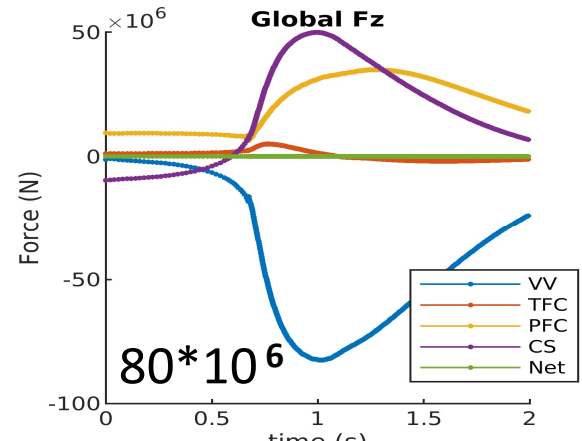
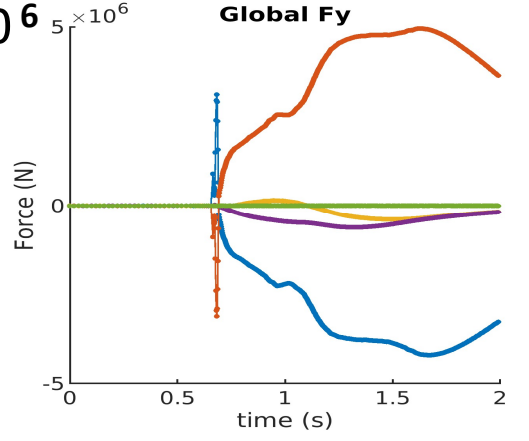

80×10^6

4.3 Comparison of VDE and AVDE net EM moments in the interaction between the VV and the Magnets, MN*m

$2 * 10^{-6}$

VDE

These plots have been built before moment balancing procedure was developed

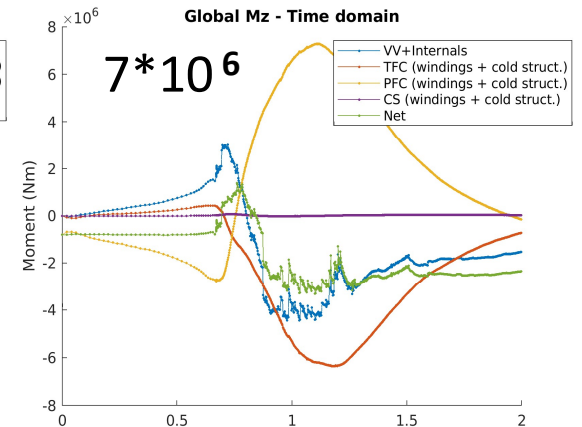
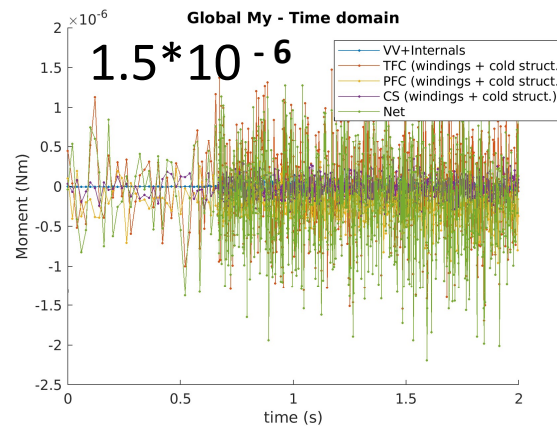
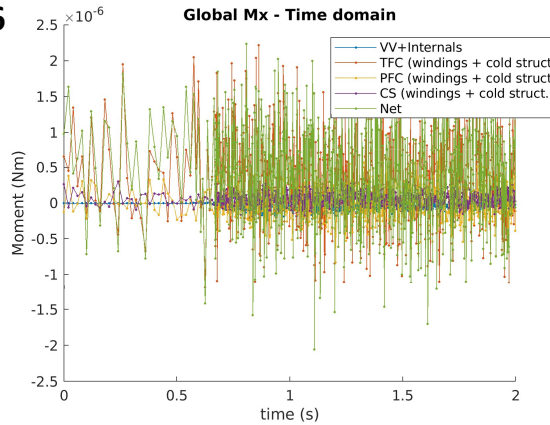

$80 * 10^6$

AVDE

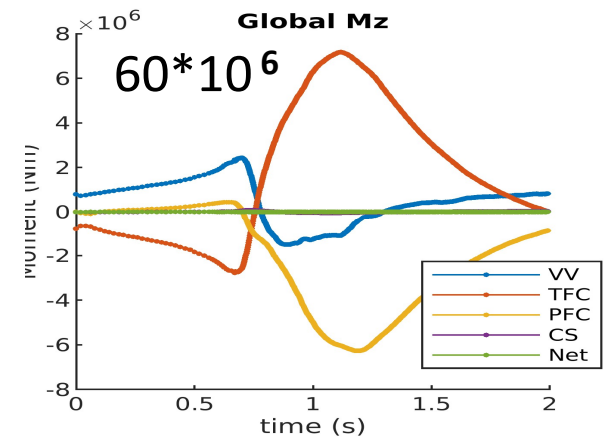
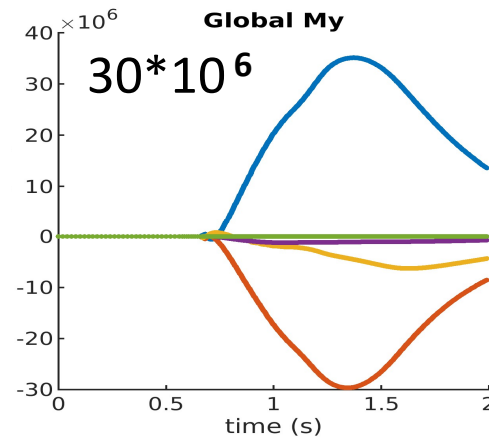
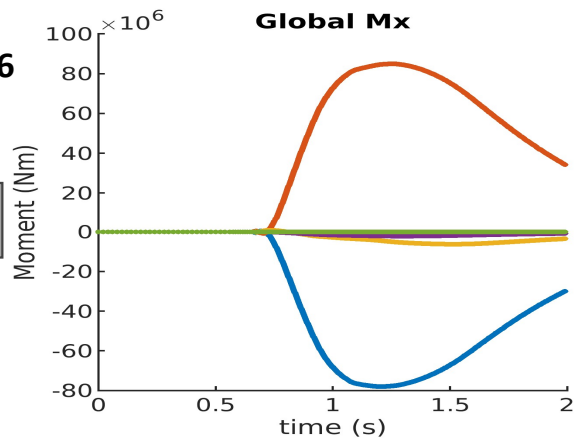

4.5 “Virtual sensors” added in tokamak dynamic model to collect “synthetic measurements” for Tokamak Monitor development

- **Virtual sensors** have been added in tokamak dynamic model right in spots where real sensors will be mount.
- **Real sensors** cannot be mount in the most critical spots with maximal strains, displacements, or accelerations: They will be mount where practically possible and will avoid too high gradients: Thus, will locate in areas of the modest strains, displacements and accelerations.
- Being fed by sensor data, synthetic now and real later, **TSM algorithms** shall generate as possible accurate information on all systems behavior in terms of local **peak** stresses, relative displacements (gap changes), peak accelerations, **peak** integral interface loads, etc.

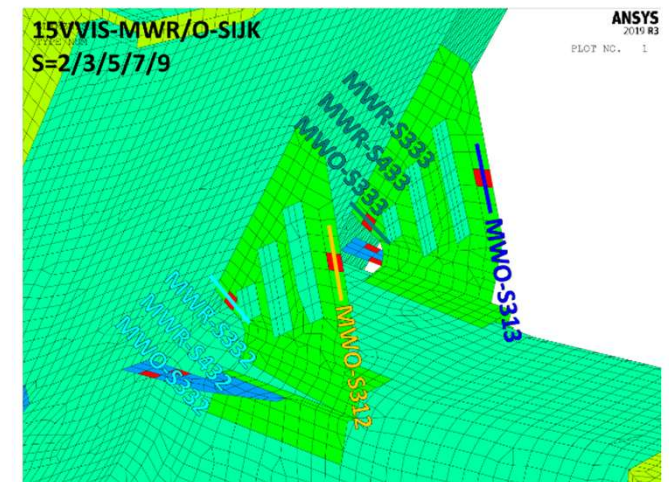
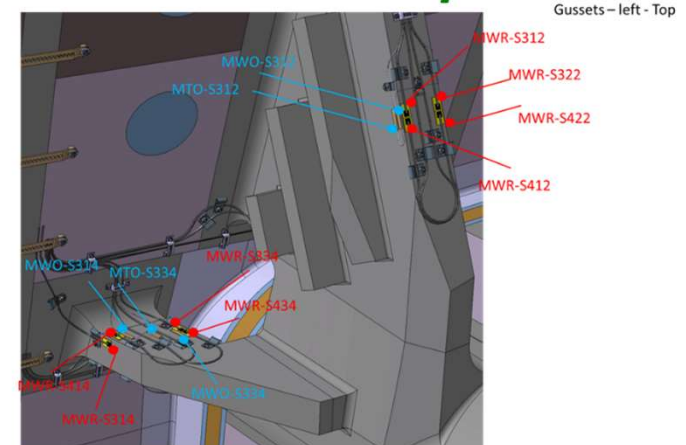

4.6 Synthetic measurements at VVGS for VDE and AVDE

- **VVGS synthetic measurements (solid lines for VDE, dotted lines for AVDE):**
 - **Relative displacement** peaks for radial direction: about 1 mm for symmetric VDE (in each support), while in the AVDE they are considerably larger: up to 3, 2 and 4 mm, due to large net lateral force.
 - Regarding the **accelerations**, there is a frequency peak clearly distinguished for the locked AVDE slightly below 7 Hz, while it is not as pronounced for the symmetric VDE,
 - **Strains** at VVGS are more similar between the AVDE and VDE, especially at the secondary hinge. Note: These strains are on the thickest solid member, stressed lesser than any surrounding parts.

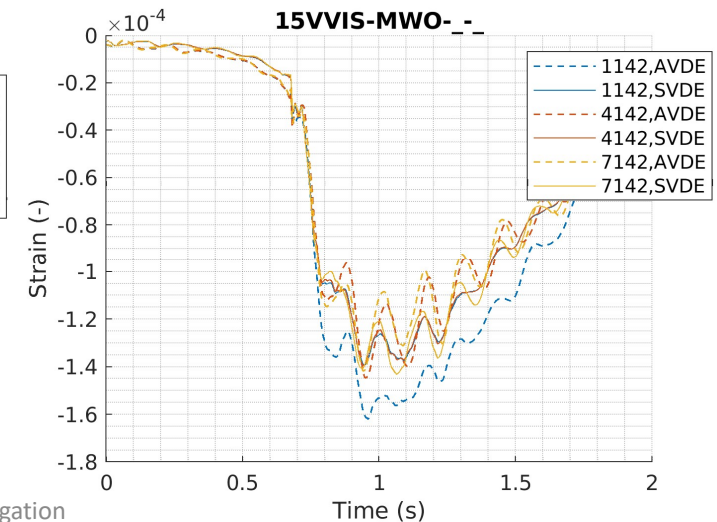
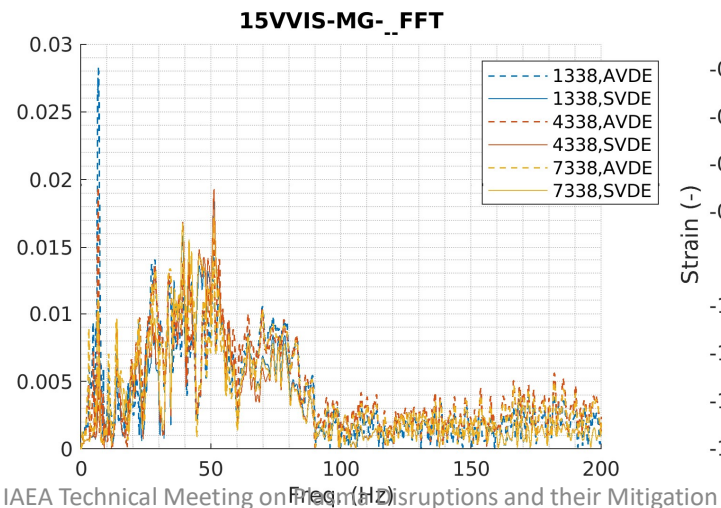
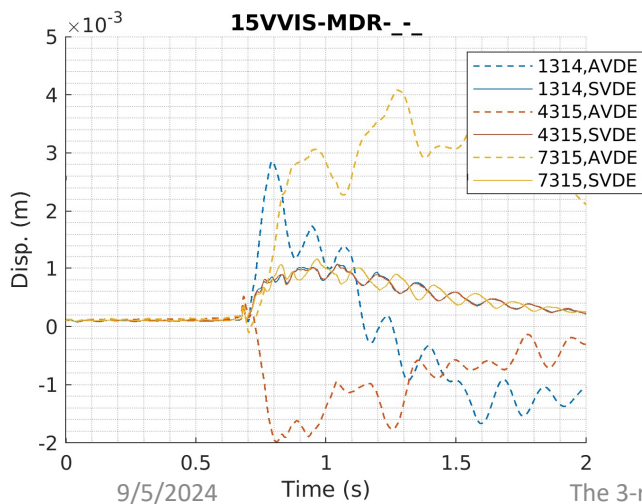

4.7 Comparison of strains in TFGS between VDE and AVDE

- **TFGS synthetic strain measurements (solid lines: VDE, dotted lines: AVDE)**
 - The asymmetry of the AVDE is observed at the **TFGS strain gauges**: there is NO change in the sign of the strains along the toroidal angle, but there are differences of up to $60 \mu\epsilon$ between sectors at 9 TF coils Gravity Supports during this specific locked AVDE
 - The bending rigidity is significantly higher around the radial axis than around the toroidal axis, which favors the relevance on the strains produced by lateral forces and moments

Strain in 9 outermost plates – right side (looking from TKM origin)

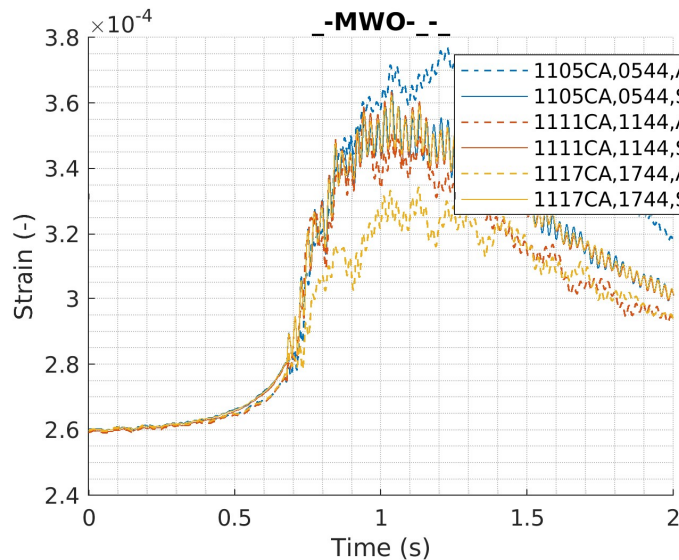

9/5/2024

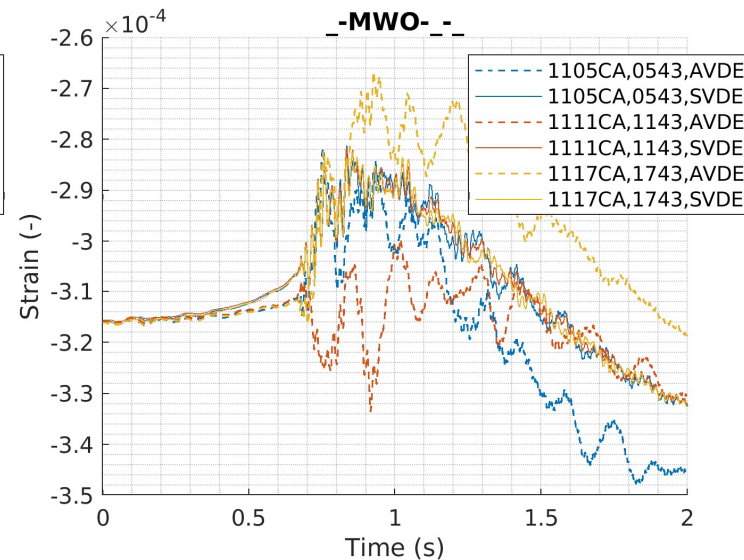

Strain in 9 innermost plates – left side (looking from TKM origin)

47

4.8 Synthetic displacements on **VV ports** for VDE and AVDE

- **VV ports synthetic displacements (solid lines: VDE, dotted lines: AVDE):**
 - At AVDE loads, the asymmetry in magnitude of vertical relative **displacement** between the cryostat and the **VV equatorial port extensions** ranges from 3 mm to 6mm,
 - **Vibrations** at sectors #4 and #7 are in phase, whereas at sector #1 they are in counter phase,
 - Peak **deflection** of **DNB port** grows by 2 mm (10mm -> 12mm) for AVDE compared with VDE.

VV EQ Port
vertical
displacement

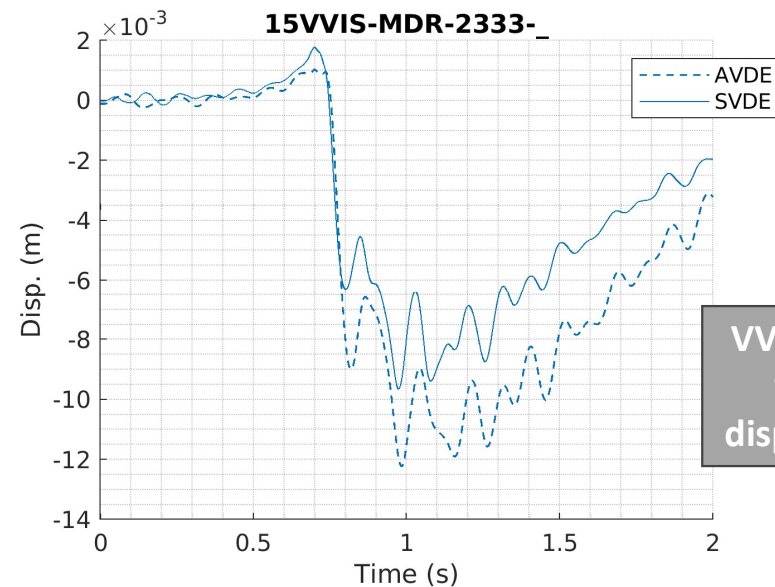
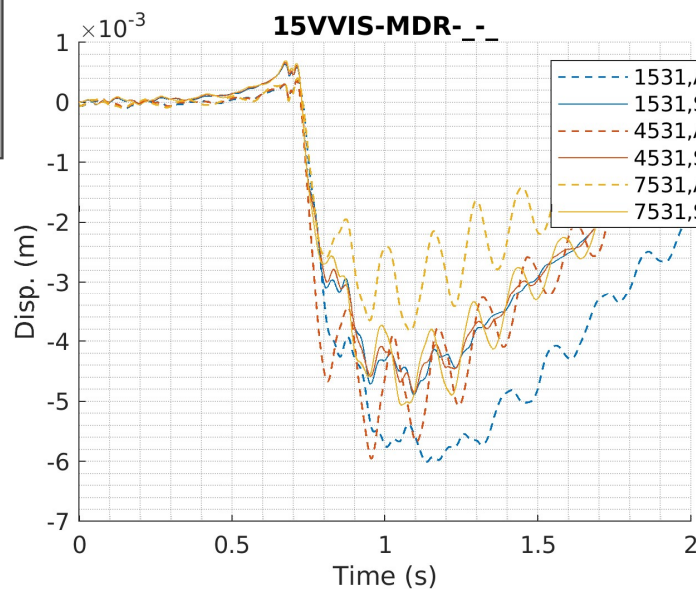

4.9 Dynamic force transfer through the Pedestal Ring

- Calculated direct EM forces and moments are in perfect equilibrium for the entire tokamak at each time instant
- However, inertial forces at VV and TFC + PFCs + CS are quite different, thus producing some force imbalance at the Pedestal Ring with three main consequences:
 1. Magnets are getting significant dynamic vibration via the Pedestal Ring and TFGS different to that of the VV,
 2. The Pedestal Ring transfers loads downward due to this dynamic mismatch, causing dynamic CSB reactions,
 3. Additional bending and torsion occurs in the Pedestal Ring and in Cryostat Walls welded to the Pedestal Ring.
- The described phenomena is observed for both VDE and AVDE, although it is almost toroidally symmetric for VDE however becomes quite asymmetric at AVDE.

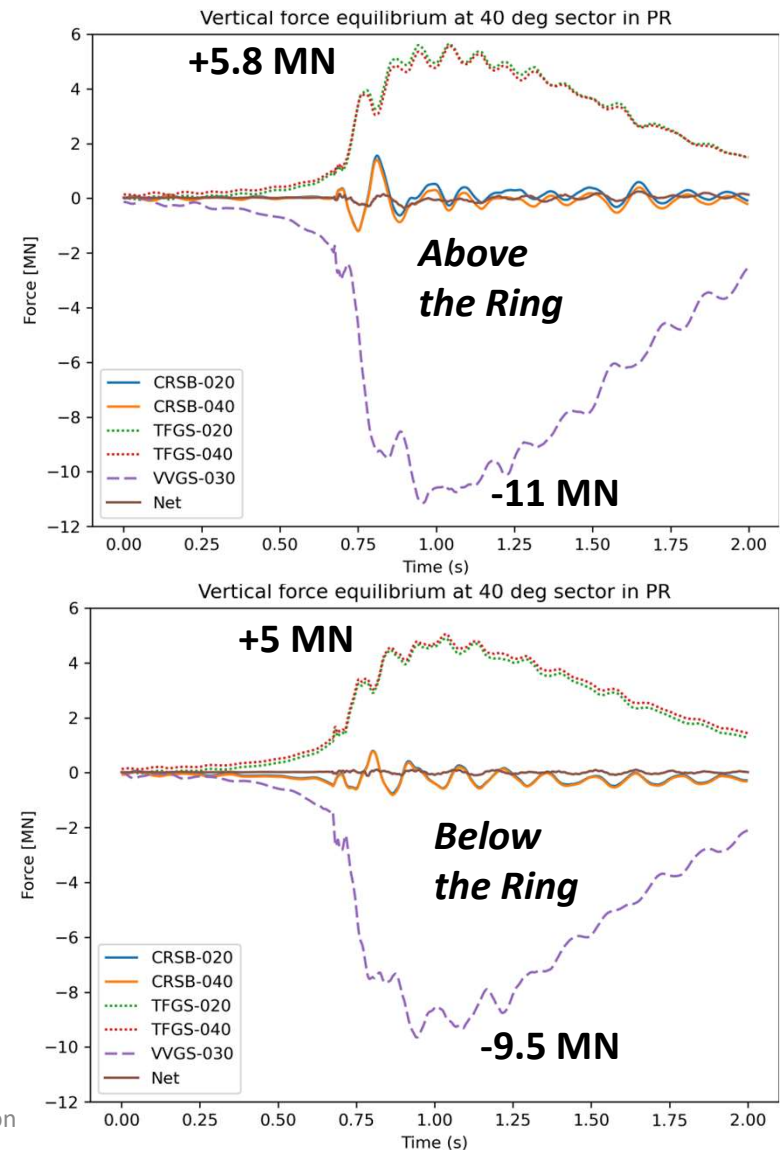

1. Introduction

2. Main features of AVDE EM model

3. Results in terms of direct EM loads

4. Tokamak dynamic response to AVDE

5. Conclusions

5.1 Conclusions on lateral forces & moments

- Unlike symmetric events, AVDE creates uneven vertical EM forces at VV sectors and uneven reactions at separate TF coils. These asymmetric forces cause quite large lateral (overturning) moments applied at the VV and reacted back at TFC system:

→ ***Lateral loads are not only net forces but also quite large net MOMENTS;***

- Supports of VV & TF coils, attachments of CS & PF coils are designed mostly for very strong vertical EM interaction (and for relatively modest 3D seismic), thus can happen to be vulnerable even for the modest lateral AVDE-induced loads:

→ ***Being designed mostly for EM interaction in vertical direction (and seismic), many supports & interfaces still to be cross-checked for lateral AVDE loads;***

- Particularly, we recommend to cross-check stress and strain states of attachments of CS & PF coils at the AVDE-driven load combinations, in the parametric manner:

→ ***CS and PF coils attachments are to be cross-checked at lateral AVDE loads;***

5.2 AVDE studies shall include dynamic response:

- Of course, “direct” EM loads are intrinsically compensated between the VV and the Magnets. However, there are quite serious differential “inertial” loads which are not intrinsically compensated as it was for the “direct” EM loads.
 - *The differential dynamic AVDE loads will propagate down through the Pedestal Ring and partly return up via the Magnets supports, thus, are to be thoughtfully quantified in the parametric manner.*

5.3 Results relevant to TSM look promising:

- The differential (around the torus) behavior of all tokamak supports and VV ports at AVDE **can be measured well enough by tokamak instrumentation** for characterization of various AVDEs by the Tokamak Systems Monitor.
- The present results in terms of **AVDE-induced local stresses, accelerations and displacements show quite measurable asymmetry** (around the torus) in VV deformation and reaction forces at VV supports and TFC supports.

5.4 *The nearest step will be the rotating AVDE*

- Our calculations have demonstrated that **even in the case of the locked AVDE sum-vector of the lateral EM force gradually rotates by almost 90 degrees**, due to a complex superposition of various 3-D EM transients.
 - *Such rotation of force vector not to be mixed with the rotating AVDE.*
- **The nearest numerical task** could be to calculate AVDE loads for the scenario **of the rotating AVDE** on already available 360 deg. EM model, with parametric variation of VDE-to-AVDE transition rate, TPF value and AVDE rotation speed.
 - *Since the presently available EM model suits for the rotating AVDE, it would be strange to not perform such the nearest step.*
- The rotating AVDE requires to explore much wider set of parametric variables,
 - *Thus, the rotating AVDE needs a larger resource for parametric studies.*

5.5 Conclusions: Overall, and next tasks:

- We think the presented approach and practical model for calculation of AVDE loads do suit well enough for the practical engineering purposes.
- Note that the present AVDE results are for scenario of **extremely slow** downward VDE and accordingly for extremely slowly evolving AVDE:
 - *Faster scenarios of VDE & AVDE evolution will demonstrate more energetic dynamic response (thus relatively stronger contribution of inertial forces).*
 - *Scenarios of **Upward** AVDE will demonstrate higher lateral moments (because of much longer arms of the lateral forces).*
- Our intention is **to fill several next cells in the “AVDE EM loads library”** at parametrically varied inputs on AVDE form and severity, beginning from the rotating AVDE. Few steps can be done with the present model.

5.6 Further parametric cases for AVDE loads

When adequate resources provided, AVDE EM loads followed by simulation of tokamak dynamic response can be calculated for the following cases:

- *For the rotating AVDE, UP & DW, slow & fast, with various rotation speed;*
- *For differently growing in time TPF and helicity, rotation speed, UP & DW, etc;*
- *Use VDE & AVDE input scenarios provided by Jorek code rather than DINA;*
- *Continue with AVDE scenarios awaited from tokamak physics community;*
- *Discussion in a course of this meeting may help with further refinements.*

References:

Copied from the latest article, and added one

1. Astapkovich, A.M.; Doinikov, N.I.; Komarov, V.M.; Korshakov, V.V.; Sadakov, S.N. Numerical modeling of the plasma disruption in a tokamak with self-consistent plasma evolution. *Vopr. At. Nauk. I Tech. Ser. Thermonucl. Synthesis. Mosc. CNNIIAtominform* **1988**, *4*, 9–15.
2. Shimomura, Y.; Wesley, J.; Astapkovich, A.; Bottura, L.; Chiochio, S.; Coccoresse, E.; Gribov, Y.U.; Hasegawa, M.; Kostenko, A.; Leuer, J.; et al. *ITER Poloidal Field System*; ITER Documentation Series, No. 27; IAEA: Vienna, Austria, 1991.
3. Sadakov, S.; Fauser, F.; Nelson, B.; Tada, E. *ITER Containment Structures*; ITER Documentation Series, No. 28; IAEA: Vienna, Austria, 1991.
4. ITER Physics Basis Editors . ITER Physics Expert Group on Disruptions, Plasma Control, and MHD. . *Nucl. Fusion* **1999**, *39*, 2251–2389.
5. Riccardo, V.; Noll, P.; Walker, S.P. Forces between plasma, vessel and TF coils during AVDE at JET. *Nucl. Fusion* **2000**, *40*, 1805.
6. Pustovitov, V. General approach to the problem of disruption forces in tokamaks. *Nucl. Fusion* **2015**, *55*, 113032. <https://doi.org/10.1088/0029-5515/55/11/113032>.
7. Artola, F.G.; Sovinec, C.R.; Jardin, S.C.; Hoelzl, M.; Clauser, C. 3D simulations of vertical displacement events in tokamaks: A benchmark of M3D-C, NIMROD and JOREK. *Phys. Plasmas* **2021**, *28*, 052511. <https://doi.org/10.1063/5.0037115>.
8. Khayrutdinov, R.R.; Lukash, V.E. Studies of plasma equilibrium and transport in a tokamak fusion device with the inverse-variable technique. *J. Comp. Phys.* **1993**, *107*, 106.
9. Paccagnella, R.; Cavinato, M.; Bolzonella, T.; Ortolani S.; Pautasso, G.; Schneider, W.; Lukash, V.; Khayrutdinov, R.; Strauss, H.R. Vertical displacement events simulations for tokamak plasmas. *Fusion Eng. Des.* **2005**, *75–79*, 589–593.
10. Glukhikh, M.I.; Sadakov, S.N. “Plasma Quest” code for pulse scenario synthesis and transient electromagnetic studies in tokamaks. *Plasma Devices Oper.* **2003**, *1*, 57–70.
11. Belov, A.; Gapionok, E.; Gornikel, I.; Kukhtin, V.; Lamzin, E.; Neubauer, O.; Sytchevsky, S. Electromagnetic transient simulation using a shell approach for ITER CXRS upper port plug due to plasma vertical displacement events. *Fusion Eng. Des.* **2011**, *86*, 1920–1923.
12. Albanese, R.; Rubinacci, G. Finite element methods for the solution of 3D eddy current problems. *Adv. Imag. Electron. Phys.* **1998**, *102*, 1–86.
13. Chen, S.; Villone, F.; Sun, Y.W.; Rubinacci, G.; Ventre, S.; Xiao, B.J.; Luo, Z.P.; Guo, Y.; Wang, H.H.; Shi, T.H.; et al. Disruptive plasma simulations in EAST including 3D effects. *Nucl. Fusion* **2019**, *59*, 106039.
14. Sadakov, S. A few points of the engineering logic discussed in ITER EDA on evaluation of Halo- and AVDE-induced loads in tokamaks. *Plasma* **2021**, *4*, 25.
15. Riccardo, V.; Walker, S.; Noll, P. Modelling magnetic forces during asymmetric vertical displacement events in JET. *Fusion Eng. Des.* **2000**, *47*, 389–402.
16. Mironov, D.V.; Pustovitov, V.D. Sideway forces due to coupled kink modes in tokamaks. *Phys. Plasmas* **2017**, *24*, 092508.
17. Sovinec, C.R.; Bunkers, K. Effects of asymmetries in computations of forced vertical displacement events Plasma Phys. *Control. Fusion* **2019**, *61*, 024003.
18. Sadakov, S.; Villone, F.; Rubinacci, G.; Ventre, S. Simple Parametric Model for Calculation of Lateral Electromagnetic Loads in Tokamaks at Asymmetric Vertical Displacement Events (AVDE). *Plasma* **2022**, *5*, 306–323.
19. Maqueda, L.; Almenara, J.; Pineiro, D.; Rodrigues, E.; Sadakov, S. Feasibility evaluation and pre-conceptual design of the ITER Tokamak Systems Monitor. *Fusion Eng. Des.* **2023**, *188*, 113435.
20. Testoni, P., Forte, R., Portone, A., Rubinacci, G., Ventre, S. Damping effect on the ITER vacuum vessel displacements during slow downward locked and rotating asymmetrical vertical displacement events. *Fusion Eng. Des.* **2018**, *136*, 265–269.
21. Sadakov, S.; Villone, F.; Iglesias, D.; Maqueda, L.; Almenara-Rescalvo, J.; Rubinacci, G.; Ventre, S. Practical Model for Calculation of Lateral Electromagnetic Loads in Tokamaks at Asymmetric Vertical Displacement Events (AVDE). *Plasma* **2024**, *7/1/12*.